

HAGELIN - GREYNER SYSTEM

Distribution: Special
Translated: RWP

20 copies

August 1949

Copy No. _____

Approved for Release by NSA on 11-19-2014 pursuant to E.O. 13526

copy 7 of 735

Dr. Edgar Gretener A. G.

Elektromechanik und Lichttechnik Zürich

31 March 1949

No. 158

Cipher devices for Teleprinter OperationHagelin - Gretener - SystemA. General

The cipher devices of the H-G system, here called TC (Tele-Chiffriergerät), serve for the automatic encipherment and decipherment of messages transmitted by teleprinters. To each of the two teleprinters of a link is assigned a TC, which takes care of the encipherment of the messages transmitted by radical change of the out-going teleprinter impulses and of the decipherment of the messages received by reconversion of the incoming teleprinter impulses (restitution of the original impulse form).

Both procedures are completely automatic. Operation of the teleprinters is exactly the same as without TC, and the messages are always written in plain text. Only the electrical impulses on the line (or in the aether) are enciphered.

Figure 1 shows schematically a teleprinter connection with TC.

B. Teleprinter Systems

The TC are built for

- a) Use with teleprinters with the International 5-element code (5-unit system).
- b) Use with ETK-Teleprinters (14-element code, combination writing) (14-unit system).

It is proposed to build two types of TC:

"Standard" for use exclusively with teleprinters of the 5-unit system.

"Universal" for use, optionally, with teleprinters of a 5-unit and of the 14-unit system.

C. The Cipher Procedurea) Cipher Procedure for a Teleprinter Connection of the 5-unit digit system.

Double current (polar) operation. (N. B. Probably TC will also be built for single current operation and single tone operation with the 5-unit system).

Connecting the teleprinters with the TC devices is very simple in this case (Figures 1 and 2). The TC are introduced into the line between the teleprinters by using two input and two output binding posts. In the teleprinters nothing need be changed. The tele-cipher device (TC_1 and TC_2) consists of the actual cipher part CH and the polarized relay R with its two make and break contacts r . It will be seen from Figure 2 that by reversing the polarity of R (throwing the contacts r) the polarity of the teleprinter line $a - b$ is reversed. The cipher impulses are produced in the cipher part CH according to a definite program and control the relay R. Hence the teleprinter line undergoes a reversal of polarity in the rhythm of the cipher impulses.

Like the teleprinters, the tele-cipher devices work on the start - stop principle. The start results from the start impulse of the teleprinter over the line st (dotted line). Through one revolution from start to stop, teleprinter and TC run synchronously, with the teleprinter producing the writing impulses and the TC the cipher impulses (or reverse polarity impulses). The matter of superimposing the two series of impulses will be explained by an example (Figure 3).

By oscillograms in Figure 3 we show how the series of impulses of the letter "R" is transformed by the reverse polarity impulses of the TC_1 into the series of impulses of the letter "O" ("cipher letter") and is reconverted at the receiving end by TC_2 into the impulse series "R". To clarify the rules of impulse encipherment, the following assumptions are made (see Figure 2).

- | | |
|---------------------------------|--|
| 1. For the teleprinter impulses | If conductor a is positive, this means "case +"
If conductor a is negative, this means "case -" |
| 2. For the TC impulses | When contact r is raised, this means "case +"
When contact r moves down, this means "case -". |

Under these presuppositions the combined effect of the different cases of teleprinter impulses and TC impulses is shown in Figure 4. This is the so-called "multiplicative" mixing of impulses (called "mixing" for short in what follows) since, for example, a " - " lead impulse arises from

Teleprinter impulse +	
TC impulse -	+ times = - -, etc.

b) Cipher Procedure for a Teleprinter Connection of the 14-unit system.

(Single tone telegraphy or single channel voice frequency telegraphy).

The wiring up of the teleprinter or the TC is here somewhat different from that of the 5-unit system because we are working here with single tone telegraphy rather than double current (polar). (See Figure 5 and description).

The functioning of the cipher process is basically, however, the same as with the 5-unit system, namely start - stop operation, production of cipher impulses which are mixed with teleprinter impulses for encipherment at the sending station and for decipherment at the receiving station. The mixing results according to Figure 4.

In the 14-unit system the 14 writing impulses correspond to the 14 elements of the combination writing. One letter consists of at most 5 of the 14 elements, as can be seen from the attached alphabet. The letter "Z" (Figure 6), for instance, arises by the combination of elements 2, 3, 6, and 9 and thus the impulse series will contain impulses 2, 3, 6, and 9. By mixing with the impulse series produced by the TC according to the "multiplicative" principle of Figure 4 there arises on the line the enciphered impulse series. The characters of this impulse series are often not readable characters. In contrast to the 5-unit system, where the (legible) cipher letter "O" was obtained from the letter "R", we here get from the letter "Z" the illegible symbol $\frac{1}{2}$. All possible combinations of 14 elements

(i. e. $2^{14} \approx 16,000$) can occur as cipher impulse series. Hence some 16,000 different cipher characters are possible, of which only about 40 are readable symbols (letters and numbers). This is the principal difference in comparison with the 5-unit system.

D. Generation and variation of the Cipher Impulse Series in the TC.

(Cipher System).

Thus far we have shown in what manner the mixture of the teleprinter impulses with the cipher impulses comes about. We shall now describe briefly the manner of generating the cipher impulses, i. e. the cipher system.

a) The pinwheels.

The pinwheels are the actual cipher elements of the TC. Accordingly their function will be explained first.

Figure 7 shows in schematic form the arrangement of pinwheels, side view and top view. All pinwheels 1 are mounted rotably on a common pinwheel shaft 3.

A pinwheel consists of

- the body 1, and attached to its rim the
- key numbers 4
- the pins 2, which can be slid axially (by hand) and project from the body either to the left or to the right.

Furthermore to each pinwheel is attached a ratchet wheel 5. The pins 2 or a pinwheel are numbered serially with key numbers starting with 01. The highest key number of a pinwheel corresponds to the number of pins (likewise the number of teeth of the ratchet wheel) and is called the division number or the division of the pin wheel. 14 different pin wheels are provided with divisions differing from pinwheel to pinwheel, as follows:

Wheel	1	2	3	4	5	6	7	8	9	10	11	12	13	14
Division	29	31	32	34	37	38	39	41	42	43	44	45	46	47

With its pins each pinwheel controls four make and break contacts, of which two are mounted on one side and two on the other side of the pinwheel body (see top view Figure 7). The two make and break contacts on one side are combined in the wiring diagram into one double make and

break contact S^0 , while the two make and break contacts on the other side function as individual make and break contacts S'' and S''' . S^0 is controlled by the pins 2 of a pinwheel through a feeler 6 and (S'' , S''' by a feeler 7. If at a definite position of the pinwheel a feeler strikes a pin, the make and break contacts are changed over (Figure 7 side view S^0), in the other event the make and break contacts are not changed over (Figure 7 side view S'' S'''). If the feelers 6 and 7 were to scan at the same point on the circumference of the pinwheel, the position of S^0 to S'' , S''' would always be complementary, i. e., if S^0 is thrown, S'' would not be thrown and vice versa, due to the fact that a pin can project from the pinwheel body only to the left or only to the right. To avoid this, the feelers 6 (right) and 7 (left) are mounted 1 pin division apart around the circumference.

The stepping [advance] of the pinwheel is accomplished by a ratchet wheel drive with ratchet wheel 5, pawl 8, lever 9, spring 10 and a swing bar 11 which is common to all the pinwheels. There is further a control magnet M which with its armature system can engage in the stepping movement. The functioning of the stepping is as follows:

With each start of the TC (i. e. with each letter struck on the teleprinter) the swing bar 11 executes a swinging movement to the position indicated by dotted lines and back again. If the control magnet M is without current, lever 9, driven by spring 10, will also execute the swinging movement and by means of pawl 8 will move ratchet wheel 5 (and with it the pinwheel) forward by one division. The swing bar 11 activates the levers 9 of all 14 pinwheels. If the control magnets are without current each of the 14 pinwheels is advanced by one pin division with each character struck on the teleprinter. (These divisions differ, however, from wheel to wheel; each wheel requires a different number of steps for a full revolution). If the control magnet of a pinwheel is excited, the armature 12 will prevent lever 9 from swinging out. The pinwheel is not advanced. Control magnets M are connected to the power source via pinwheel contacts S''' , whereby association of the control magnet of a particular pinwheel to contact S'' of another pinwheel is selective and variable.

Variants

With the pinwheels above described a pin can only project from the pinwheel body

either to the left

or to the right

hence a pin set in a particular way will activate either contact S' alone or contacts (S'' , S''') only. In order to break this rule, single pins (e. g. 1 to 2 pins in each pinwheel) are made so long that they project on both sides of the pinwheel body, and other single pins are made so short that they project neither to the right nor to the left. Of course these two types of pins are not settable.

In Figure 8 the entire arrangement of the pinwheels is shown schematically. In addition to the pinwheels the rotary feed switches S_p and rotary separator switches Tr (variant 1) or permutation switch P_y and permutation switch P_z (variant 2) are mounted on the pinwheel shafts; these are controlled by control magnets M_{S_p} and M_{Tr} (variant 1) or M_y and M_z (variant 2) (explanation below).

b) If one introduces a double make and break contact according to Figure 9a into a double lead $a - b$, then by activating the double make and break contact the polarity of the lead is reversed. For the sake of simplicity the four pole connection of Figure 9a will be replaced by the symbol of Figure 9b, i. e. Figure 9b represents a "lead polarity reversing double make and break contact" or for brevity a "polarity reverser". If one connects several such polarity reversers in a chain [in series] (e. g. 6 units (S_1 to S_6)) according to Figure 10 and applies to the input posts a dc voltage (Gleichspannung) of definite polarity, then the polarity of the output post is dependent on the position of all 6 polarity reversers. If we designate the "non-polarity reversing" position of the polarity reversers by + (contacts up in Figure 9a) and the "reversing" position by - (contacts down in Figure 9a) then we get as result (polarity of the output posts) the sign product of the signs from 1 to 6, e. g.

	S^0_1	S^0_2	S^0_3	S^0_4	S^0_5	S^0_6	Result
	-	+	+	-	-	+	-
or	-	-	+	+	+	+	+

Result - = Output polarity reversed with respect to input.

Result + = Output polarity not reversed with respect to input.

In Figure 11 there has been inserted between each two polarity reversers of a polarity reverser chain a condenser which is brought into contact with the one or the other branch of the polarity reverser chain selectively through a make and break contact S^0 . All condensers are connected on one side in series and to the - pole of the input. The condensers may be charged or not. Whether C_1 is charged, depends on the position of S^0_1 and S^0_1 . Whether C_4 is charged depends on the position of S^0_1 , S^0_2 , S^0_3 , S^0_4 , and S^0_4 etc.

Figure 12 gives the basic diagram (variant 1, for variant 2 see Figure 12a and Section D. e) for the Hagelin-Gretener cipher system. There is a chain of polarity reversers with the reversers S^0_1 , S^0_2 ... S^0_{14} . (These polarity reversers are the 14 double make and break contacts of the pinwheels.) The input or feed to the chain of polarity reversers is located at the leads marked Sp (the so-called rotary feed switch).

The chain of polarity reversers must not of course form a closed circuit. Therefore it is broken at a point designated by Tr (rotary separator switch).

In a manner similar to that in Figure 11, 14 condensers C_1 to C_{14} are connected to the chain of polarity reversers through the simple make and break contacts S^0_1 to S^0_{14} . (These simple make and break contacts are those of the pinwheels.) Furthermore these diagrams contain the distributor commutators for the 5-unit system and the 14-unit system. With the 14-unit system each of the 14 condensers is connected to one of the 14 commutator segments and in the 5-unit system every third condenser is connected to one of the 5 commutator segments. The condensers can be disconnected from

the chain of polarity reversers through the cam contacts n_1 to n_{14}

[Nockenkontakt]. The magnets M_1 to M_{14} are the control magnets of the pinwheels which in turn are controlled by the pinwheel contacts S''_1 to S''_{14} .

Q The rotary feeder switch Sp through which current is introduced to the chain of polarity reversers is stepped one "division" of the chain of polarity reversers in the direction of the arrow each time a character is struck on the teleprinter (start of the TC) and analogously the rotary separator switch, e. g. in the opposite direction. The forward movements of the rotary feeder switch and of the rotary separator switch are controlled ^{however, nonetheless} (in addition) by the control magnets MSp and MTr, so that there is only an advance in reality when the corresponding magnet is without current. MSp and MTr in their turn are controlled by pinwheel contacts. In this way the charge of any condenser is dependent on a constantly changing number and a constantly changing arrangement of the pinwheels. Polarity reverser S₀, which is introduced into the lead to the chain of polarity reversers, is controlled by a pinwheel (through a relay which is not shown), whose control magnet is constantly without current (stepping each time a key is struck). This prevents reaching a position in which all pinwheels stand still (all control magnets are excited).

The condenser C₇, for instance, in the position shown in the drawing receives its charge (or "no-charge") from the rotary feed and separator switch through the polarity reversers

$S_0, S'_2, S'_3, S'_4, S'_5, S'_6, S'_7$

and the make and break contact S⁰7. If when the next key is struck, Sp for instance stands still while Tr moves one "division" in the direction of the arrow (so that the separation of the chain of polarity reversers is between S⁰6 and S⁰7) then the charge of C₇ after the next key is struck depends upon

$S_0, S'_1, S'_{14}, S'_{13}, S'_{12}, S'_{11}, S'_{10}, S'_9, S'_8$ and S⁰7.

What happens when enciphering a letter (or a digit) is as follows (see Figure 13):

In the stop position of the TC the cam contacts [Nockenkontakte] n are closed. The condensers are connected to the chain of polarity reversers and are charged or not charged, just according to the "accidental" product of the contact positions of the momentarily associated pinwheel contacts. By striking a key on the teleprinter the control shaft of the TC is started and makes a complete revolution (synchronized with the control shaft of the teleprinter). Since each condenser leads to one commutator segment, during the course of this revolution the condenser voltages of $C_1, C_2, C_3 \dots$ etc. are taken off one after the other by means of the brush and conducted to the amplifier V . The impulses thus obtained at the output of the amplifier are the previously described cipher impulses, which control the polarized relay R (see also Figure 3 and Figure 5). The proceeding is the same for the 5-unit system and the 14-unit system. Only in one case there is a 5-part (+ start - stop - segment) commutator and in the other a 14-part (+ start - stop - segment) commutator.

During the revolution of the control shaft of the TC (during the time of sending out and enciphering 1 character) the advance of the pinwheels must occur simultaneously. This, however, means a complete change of the positions of the pinwheel contacts. So that, despite this change, the condenser charges may remain constant over a complete revolution of the collector brush (control shaft), all condensers are cut off from the pinwheel contact by the cam contacts n shortly before the start and are connected up again shortly before the stop. The condensers serve as storers.

It is clear that each new series of cipher impulses is completely different from the preceding.

c) Additional Substitution

In order to avoid having the polarity reverser S'_1 (of pinwheel 1) connected constantly to polarity reverser S'_2 (of pinwheel 2), and this latter to S'_3 , etc., the manner of connecting the pinwheel contacts is made subject to substitution. The substitution points are indicated in diagram Figure 12 by

- 1) X_1 to X_{14} "Sequence in the chain of polarity reversers"
Substitution key 1
- 2) Y_1 to Y_{14} "Association of the pinwheel make and break contacts S"
to the chain of polarity reversers".
Substitution key 2.
- 3) Z_1 to Z_{14} "Association of the storage condensers".
Substitution key 3.
- 4) W_1 to W_{14} "Association of the control magnets to pinwheel
contacts S⁰".
Substitution key 4.

The substitutions always take place within a series, thus x with x,
y with y, etc.

Figure 14 shows a substitution scheme for the substitution $X_1 - X_{14}$.
Polarity reverser S'_1 for instance is no longer connected directly with
 S'_2 via X_1 but the leads a' b' lead through the permutation switch P_x to S'_8
etc. The permutation switch wheel P_x has fourteen divisions. The internal
connections are made according to an arbitrary plan.

Normally the permutation switch wheel is made so that it can be turned
and set by hand while the lead connections (sliding contact) are fixed.
By turning the permutation switch wheel one or more segments the association
of the polarity reversers is completely shifted. The 14 segments are
numbered (01 to 14) in order to define the position of the permutation
switch wheel. (Permutation switch key numbers).

The internal connections of the permutation switch wheel may be
changed by

- resoldering or
- by changing the screws or
- by changing the plugging.

The shifts of Y_1 to Y_{14} are made in analogous fashion. A permutation
switch wheel P_y of like construction is provided.

For the shifts $Z_1 - Z_{14}$ (condenser leads) and $W_1 - W_{14}$ (control magnets)
similar permutation switch wheels P_z and P_w are provided; in these cases
however the substitution leads will no longer be two pole but one pole,
corresponding to the diagram.

Accordingly 4 permutations switch wheels (each with 14 segments, permutation switch wheel key numbers 1 to 14) are present, which normally are only turned and set by hand and then remain in this position for one or more messages.

As a further variation it would be possible instead of using only one permutation switch wheel, to use 2 or 3 of them which would be connected in series according to the familiar principle of the permutation switch cipher machine.

Whether the changing of internal connections is to be made more or less convenient, depends on the wishes of the customer.

d) The make-up of the various cipher keys

1) Pin position (left - right)

on the 14 pin wheels. Each pin can be pushed so that it projects to the left or right from the pin wheel. The pins are numbered (see Figure 7).

There are 548 pins in all.

Setting by hand.

The pin positions do not change while the machine is running.

2) Pinwheel settings

Setting of the 14 pinwheels by turning them by hand according to prearranged key. E. g. setting of pinwheel 1 on key number 5, pinwheel 2 on key number 12 (Figure 7) etc.

The pinwheel settings change while the machine is running due to the stepping (controlled by the control magnets).

(There is a changed key for each new letter).

The initial setting of the pinwheels at the beginning of a transmission is regarded as the key.

N.B. The TC is provided with a counter, which counts every character struck on the teleprinter (i. e. every stepping of the pinwheels). Therefore a number of transmissions may be undertaken with a single initial setting. It is only necessary to transmit (in clear) the counter reading before each new transmission.

2a) Initial setting of the rotary feed switch and the rotary separator switch.

(Similar to that with the pinwheels).

3) Setting of the permutation switch wheels.

Setting of the four 14-part permutation switches by hand. Normally no automatic stepping (no change of the key as set while the machine is running).

4) Type of internal connections of the permutation switch wheels.

The internal connections of the permutation switch wheels, e. g. according to Figure 14, can be altered (by hand) more or less frequently according to a prearranged key. These connections are normally soldered. However they can be by screws or by plugs.

e) Variant 2

Figure 12a gives a diagram of variant 2 of the telecipher device. Wiring and manner of operation are very similar to the above described variant 1. The only differences are:

1. Rotary feed and separator switches fall out. *[are not used in this variation]*
2. The 2 pole permutation switch wheels P_x and P_y , likewise the 1 pole permutation switch wheel P_z now have 28 parts each.
(28 positions marked by numbers).
3. The internal connections of the permutation switch wheels are now by plugging.
4. The permutation switch wheels P_y and P_z are mounted on the pinwheel shaft (Figure 8). They are set by hand and are advanced automatically (1 division at a time) while the machine is running. They are controlled by the control magnets M_y and M_z .
5. Permutation switch wheel P_x is set only by hand.
(No change while the machine is running).

The introduction of feed voltages is at 4 points, namely by the leads 1, 2 for instance at (5), by 3, 4 at (27), by

5, 6 at (21) and by 7, 8 at (19). These leads can be switched at will by plugging in permutation switch wheel Px (just like all other switchable leads). From time to time at the feed inlet in the permutation switch wheel, the chain of polarity reversers is separated by cutting off the substitution lead (Figure 12a). In this way there arise 4 parts of the chain of polarity reversers, each separate from the other, and their composition is naturally different from Px for each switch position.

6. The association of control magnets M_1 to M_{14} of the pinwheels, as well as M_y and M_z to the pinwheel contacts S''_1 to S''_{14} can be chosen at will and substitutions made by hand plugging.

Here however no permutation switch wheel is provided.

(S''_{14} is controlled by a pinwheel whose control magnet is artificially deprived of current permanently, i. e. this pinwheel always steps).

E. Mechanical Details

The drive of the control shaft with the commutators (for the cipher impulse generation), the cam plates, as well as the drive for the stepping of the pinwheels, is taken care of by an electric motor (via gears). The speed is regulated by a centrifugal switch. Between motor and control shaft is a coupling of special construction, which is controlled by a low power starting magnet. This starting magnet in turn operates at the starting impulse of the teleprinter. With each start impulse the coupling engages spontaneously whereupon the control shafts makes one revolution.

The construction of the TC is such that there is an upper part containing primarily the mechanical portion (pinwheels, control shaft, motor, etc.). This upper part is mounted on a lower part in such manner that it can be tipped back; the lower part contains primarily electrical components (amplifiers, rectifiers etc.).

F. Technical data.

(Universal Type)

1. Teleprinter system.

The TC can be switched over for operation in the

a) 5-unit system (international teleprinter system).

- double current (polar) operation.

b) 14-unit system (ETK)

- single tone operation.

2. Feed voltages.

The TC can be connected to

a) Line ac voltages

110, 125, 145, 220, 250 volts.

b) Battery dc voltage

12 volts.

3. Power consumption

a) Line operation : ca 90 VA.

b) Battery operation: ca 60 watt.

4. Revolutions

a) Motor 4000 rpm.

b) Control Shaft, can be shifted by replacing two drive wheels for

a) 5-unit system

Continuous: 480 rpm

Writing speed 428 characters per min.

b) 14-unit system

Continuous: 355 rpm

Writing speed 300 characters per min.

5. Tubes optionally:a) European: 1 EZ 40

2 EL 42

3 EB 41

or:

b) American: 1 7 Y 4

2 7 B 5

3 6 H 6

6. Fuses

1	8	A
2	0.1	A
2	2	A
1	6	A

7. Dimensions

ca. 400 x 335 x 180 mm.

8. Weight

ca. 15 kg. (without carrying case)

9. Instructions for operation

Table of contents

- A. General
- B. Teleprinter system
- C. Cipher procedure
 - a) Cipher procedure for teleprinter line of the 5-unit system.
 - b) Cipher procedure for teleprinter line of the 14-unit system.
- D. Generation and variation of the cipher impulses, in the TC (cipher system).
 - a) The pinwheels
 - b) Wiring diagrams (Variant 1)
 - c) Additional substitution.
 - d) Make-up of the various cipher keys.
 - e) Variant 2. Wiring diagram and method of operation.
- E. Mechanical details.
- F. Technical data.
- G. Operating instructions.

Fig. 1

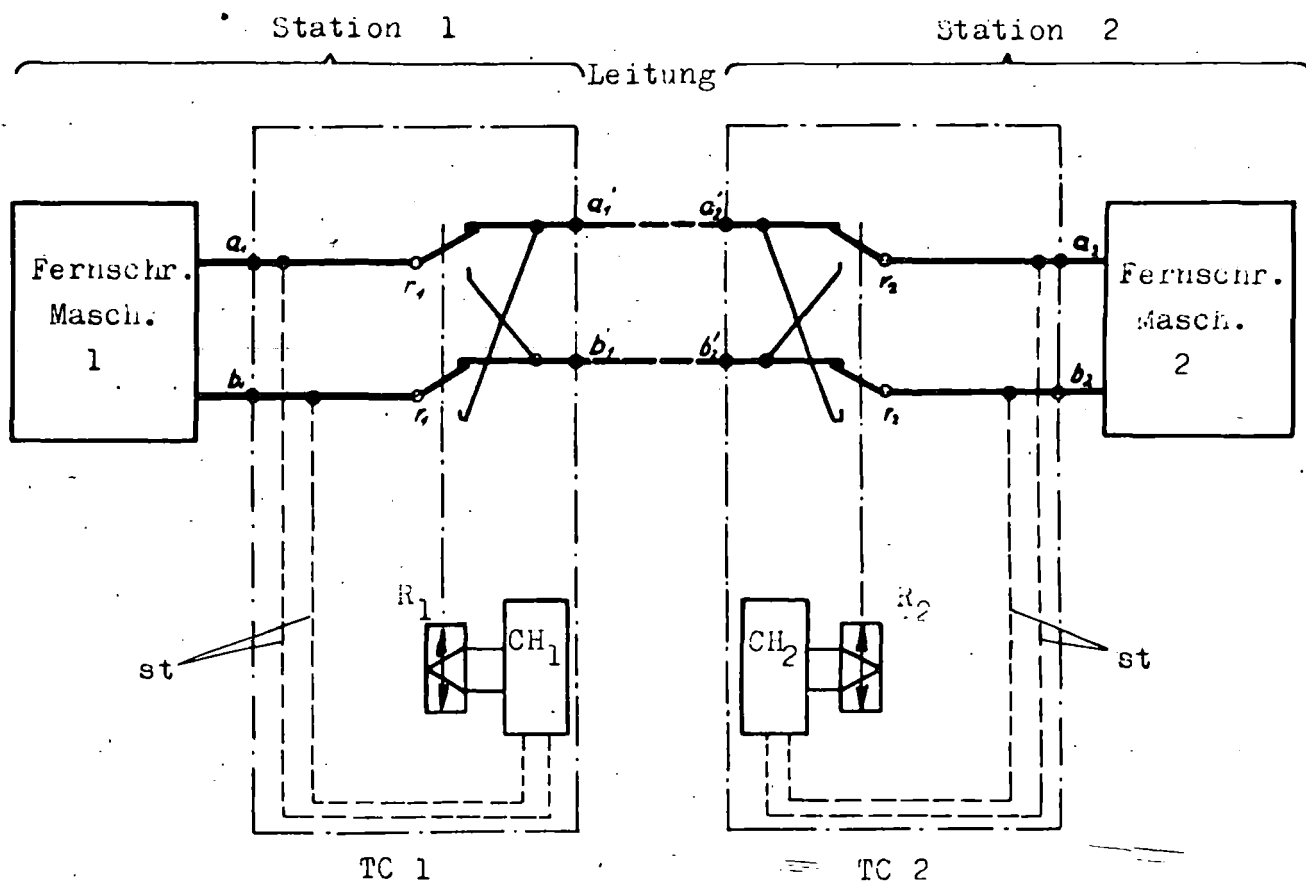
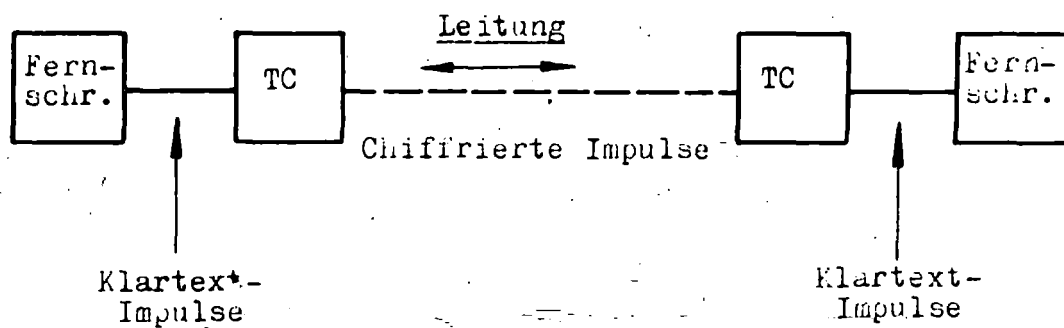


Fig. 2

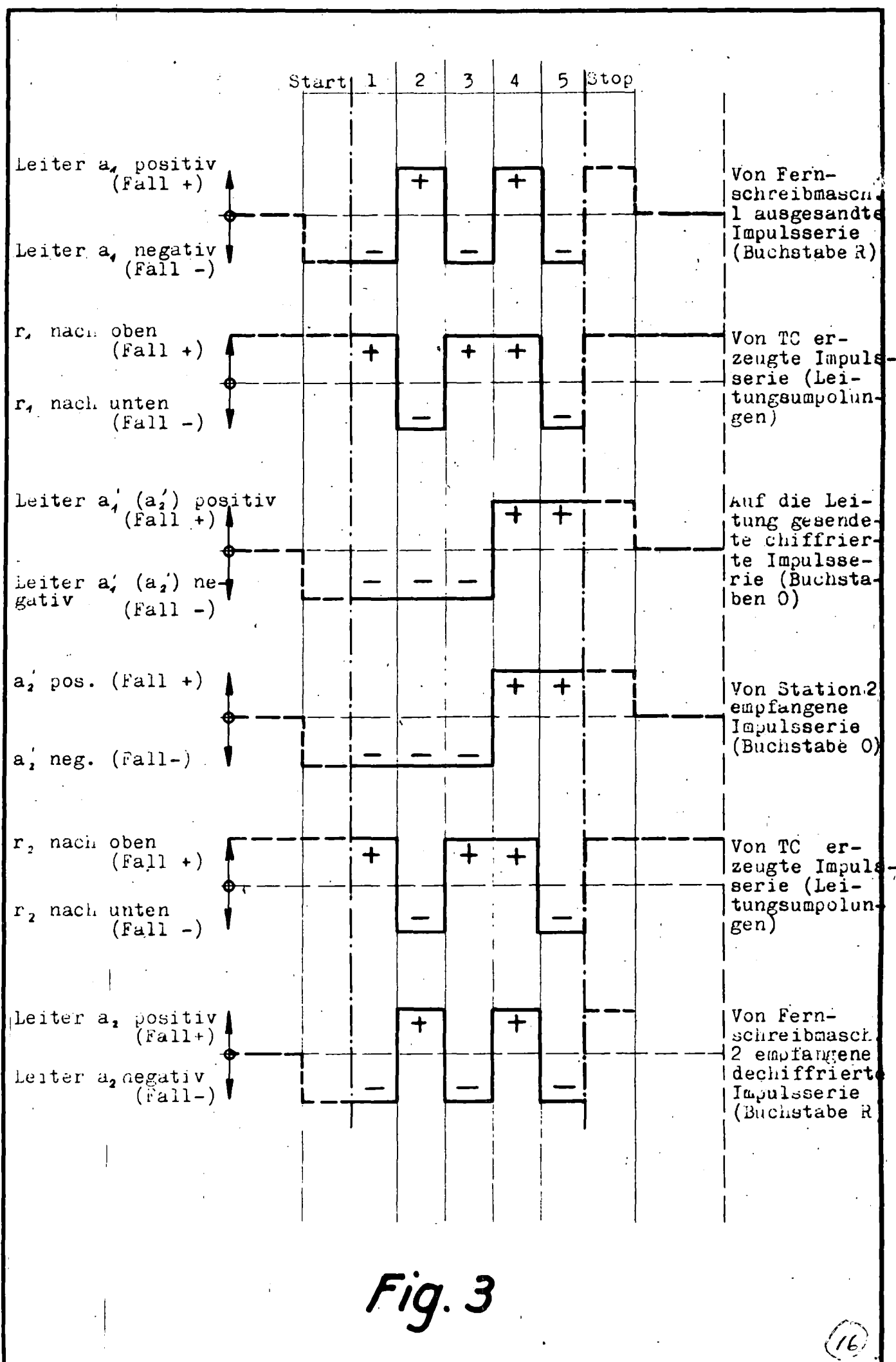


Fig. 3

		Fälle			
Senden	Fernschreibimpulse	+	+	-	-
	TC - Impulse	+	-	+	-
	Leitungs-Impulse	+	-	-	+
Empfang	Leitungs-Impulse	+	-	-	+
	TC - Impulse	+	-	+	-
	Fernschreibimpulse	+	+	-	-

Fig. 4

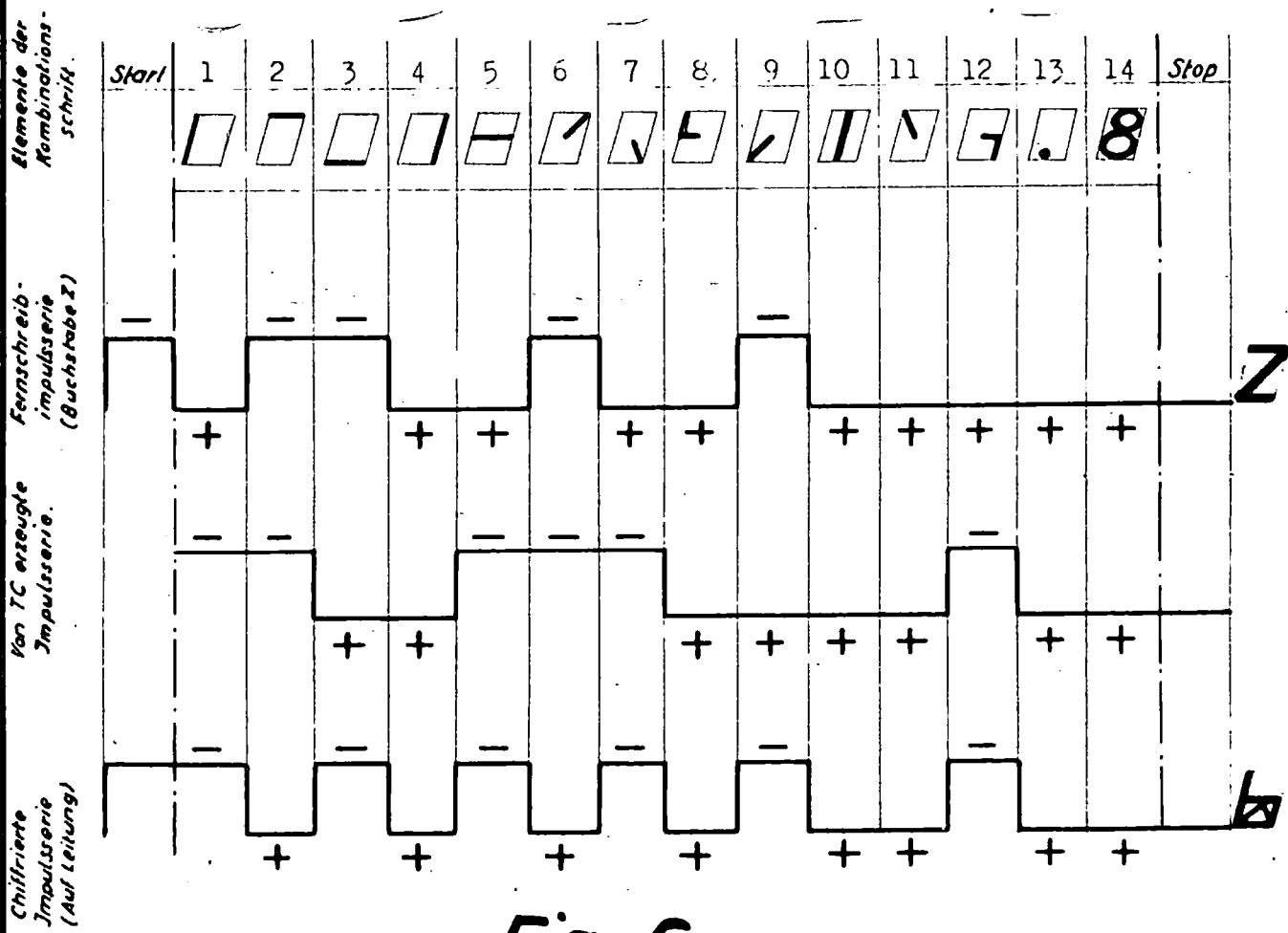


Fig. 6

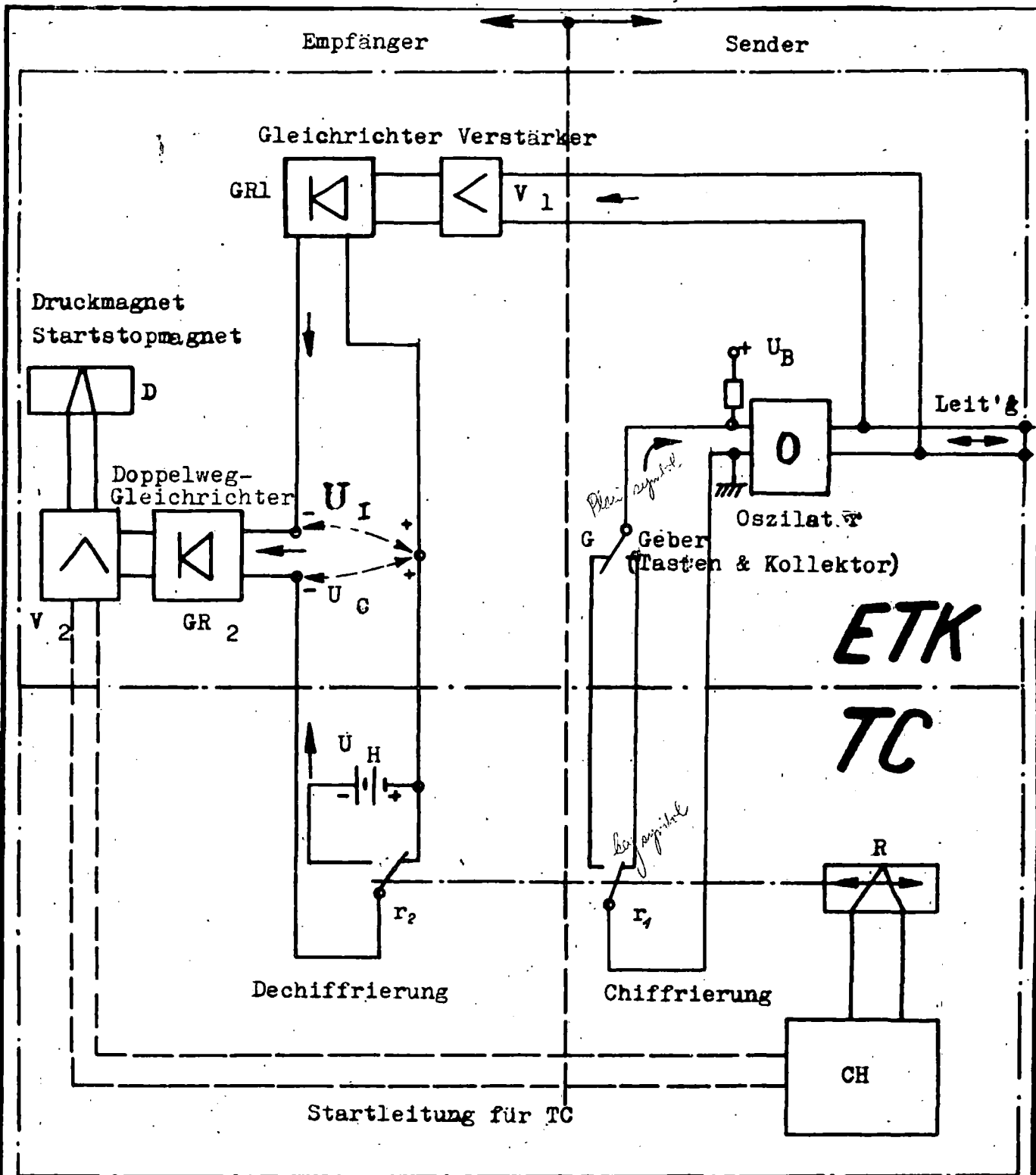


Fig. 5

Prinzipschema von ETK-Maschine mit TC-Gerät.

Vorgang : A. Senden

a) Bildung der chiffrierten Wechselstromimpulse (Chiffrierung).
 Durch Drücken einer Taste des ETK-Schreibers : Gleichzeitige Auslösung des Startes von Schreiber und TC-Gerät.

1. (18)

Diagram of the ETK machine with TC device.Procedure: A. Sending

- a) Formation of the enciphered ac impulses (encipherment) by pressing a key of the ETK printer: simultaneous release of the start of the printer and the TC device. Generation of the ETK impulse series in the sender G and of the cipher impulse series (control by relay R with contacts r_1 and r_2 through CH). "Multiplicative" mixing of the two impulse series ($G - r_1$, see diagram) and optimum operation [? Aussteuerung] of the oscillator with this impulse product. Formation of the enciphered ac impulses (1500 cycles) which are sent to the line.
- b) Formation of the plain text impulse series for the printer magnet and printing (decipherment).

The enciphered ac impulses from the line come via amplifier V_1 to rectifier GR_1 and form the (cipher) dc impulse series U_1 . An auxiliary voltage U_H is controlled by contact r_2 of the polarized relay R and forms the cipher impulse series U_c . With the polarity of the two impulse series indicated in the diagram we get once more a "multiplicative" mixing, so that at the output of the double path rectifier GR_2 the deciphered (plain text) impulse series appears, which operates the printer magnet (plain text) via amplifier V_2 .

The plain text impulse series controlling the printer magnet does not therefore come directly from the sender of the ETK machine but the cipher impulse series formed by ($G - r_1$) is deciphered by ($U_1 - U_c$ or r_2).

B. Reception

The enciphered ac impulses coming from the line are transformed into plain text according to A, b) just as in sending.

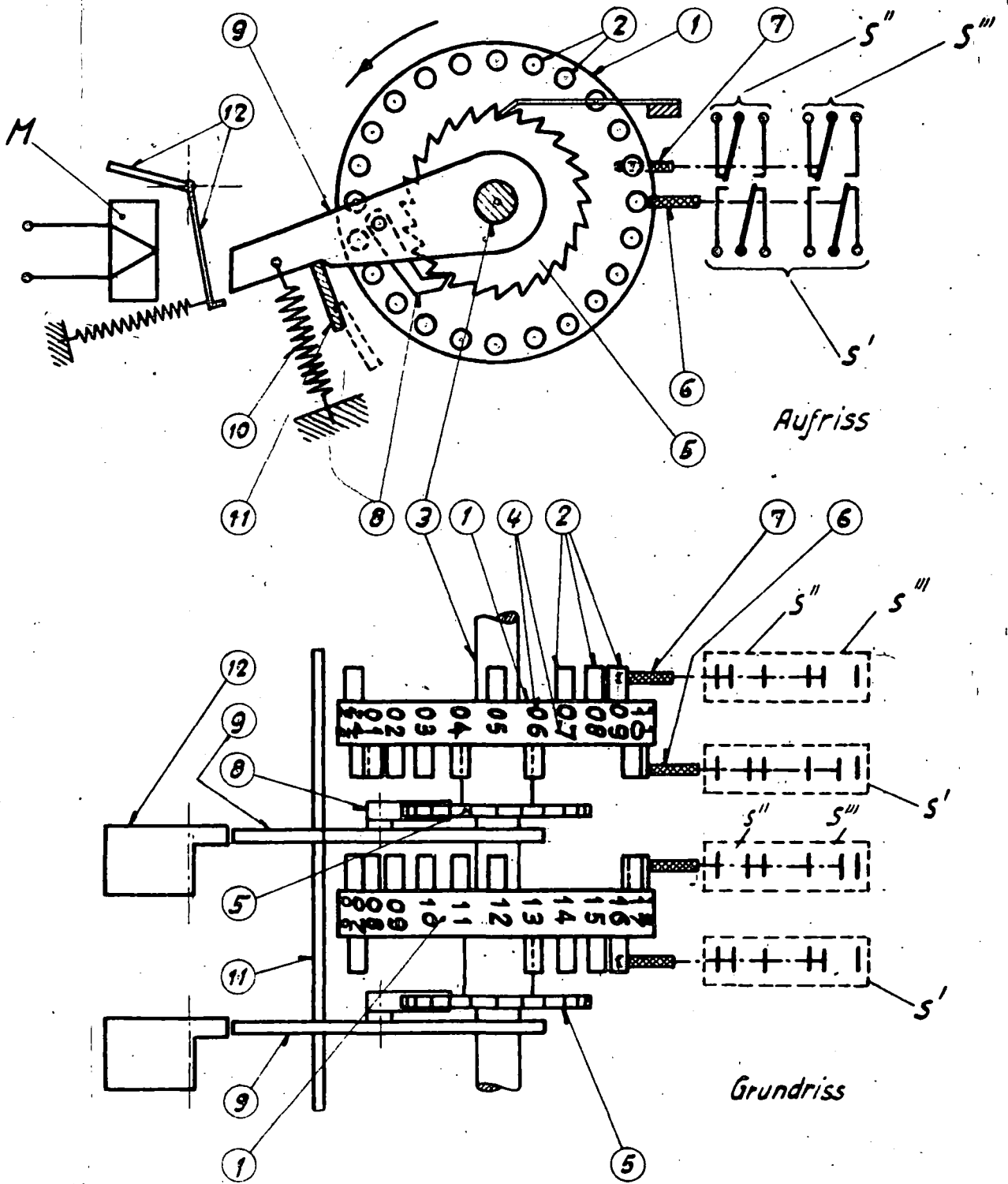


Fig. 7.

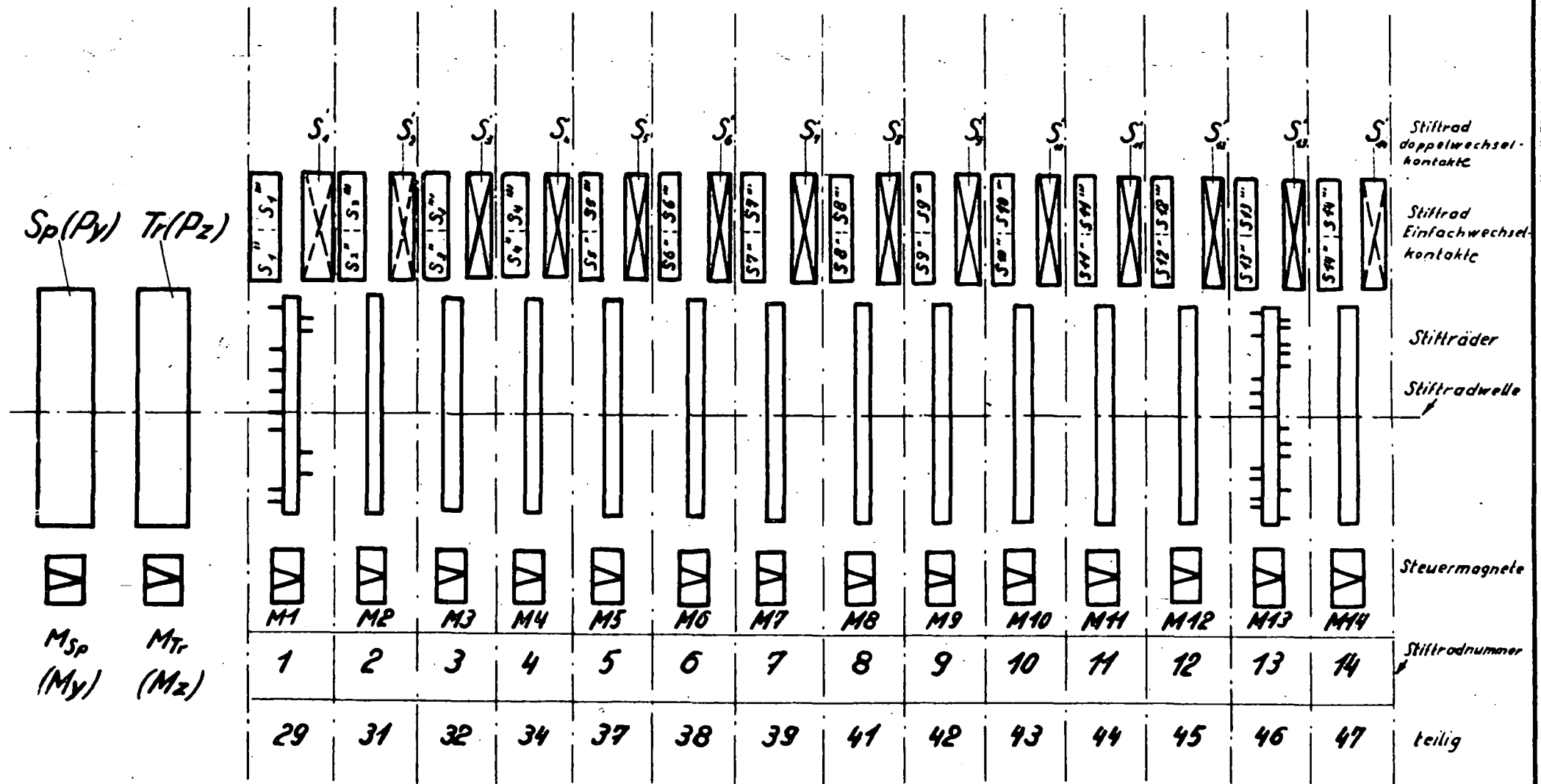


Fig. 8

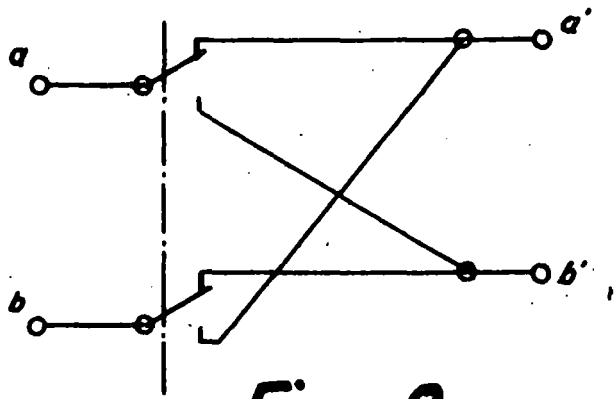


Fig. 9a

≡

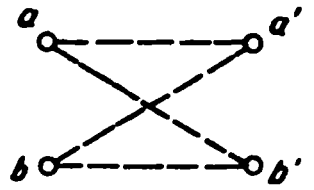


Fig. 9b

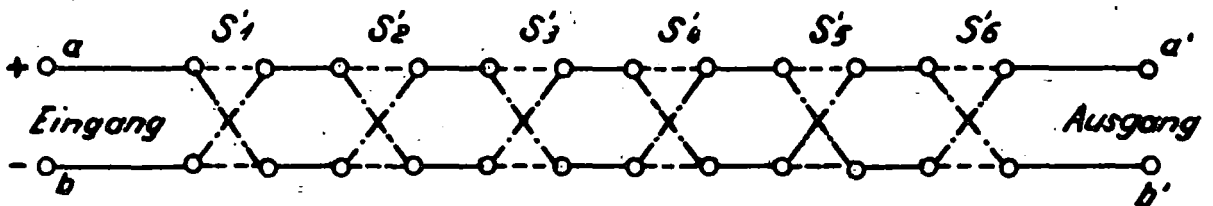


Fig. 10

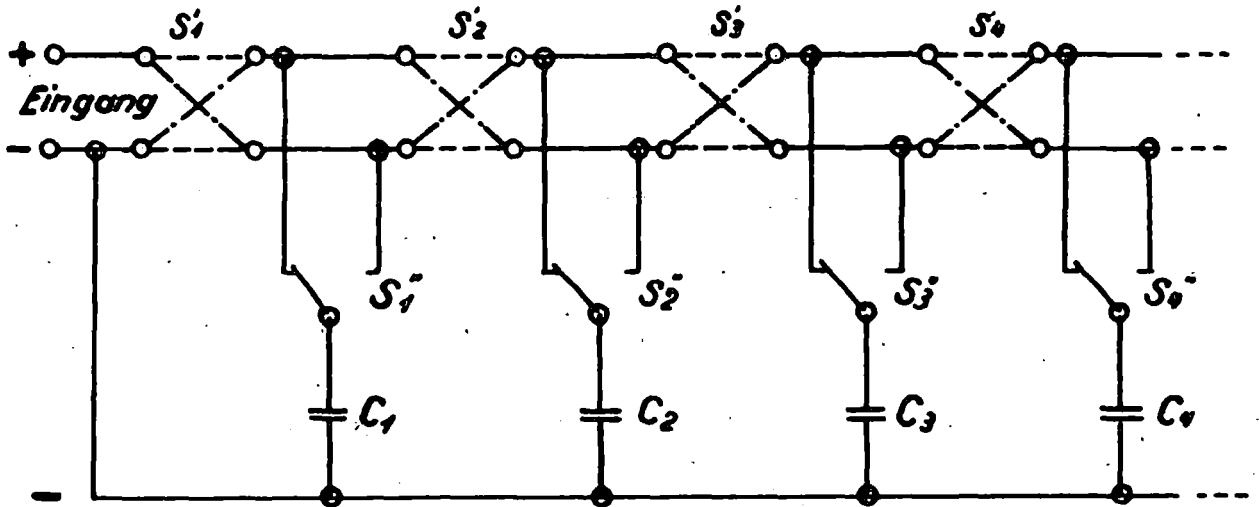
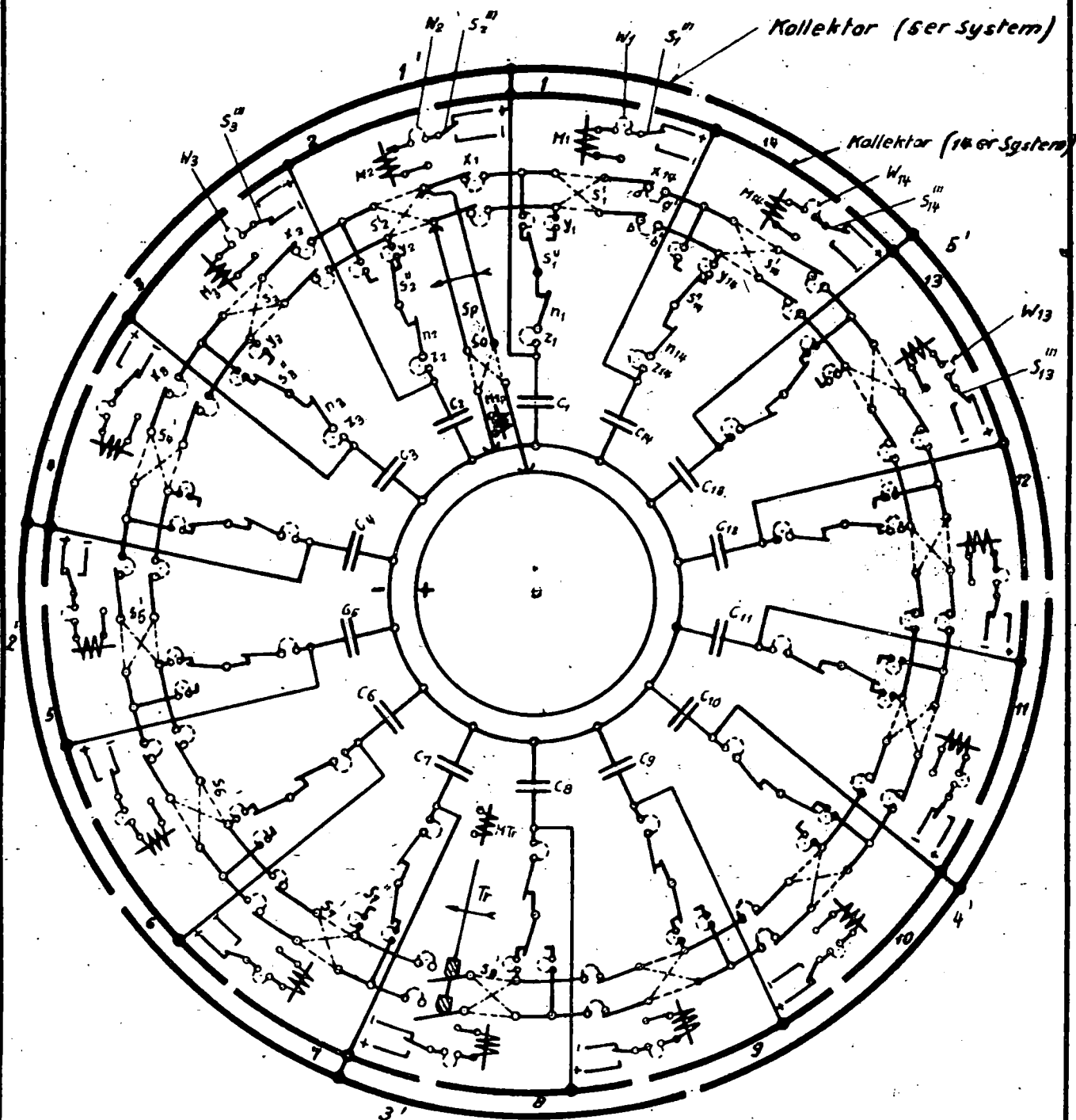


Fig. 11

TelechiffriergerätChiffriersystem Hagelin-Gretener
Prinzipschema Variante I.

- Legende:**
- | | |
|--|--------------------------------------|
| 1 + 14 | = Kollektorlamellen |
| S ₁ ' + S ₁₄ ' | = Stiftrad- Doppelwechselkontakte |
| S ₁ '' + S ₁₄ '' | = Stiftrad- Einfachwechselkontakte |
| n ₁ + n ₁₄ | = La de- Nockenkontakte |
| M ₁ + M ₁₄ | = Stiftrad- Schaltmagnete |
| Sp | = Speise- Drehschalter |
| Tr | = Trenn- Drehschalter |
| M _{Sp} | = Speise- Drehschalter- Schaltmagnet |
| M _{Tr} | = Trenn- Drehschalter- Schaltmagnet |
| C ₁ + C ₁₄ | = Speicherkondensatoren |
| X ₁ + X ₁₄ | = Vertauschungsschlüssel 1 |
| Y ₁ + Y ₁₄ | = Vertauschungsschlüssel 2 |
| Z ₁ + Z ₁₄ | = Vertauschungsschlüssel 3 |
| W ₁ + W ₁₄ | = Vertauschungsschlüssel 4. |

Fig. 12

Dat. 24. 2. 49.

N. 14. Et.

Nn. EPS 35/1

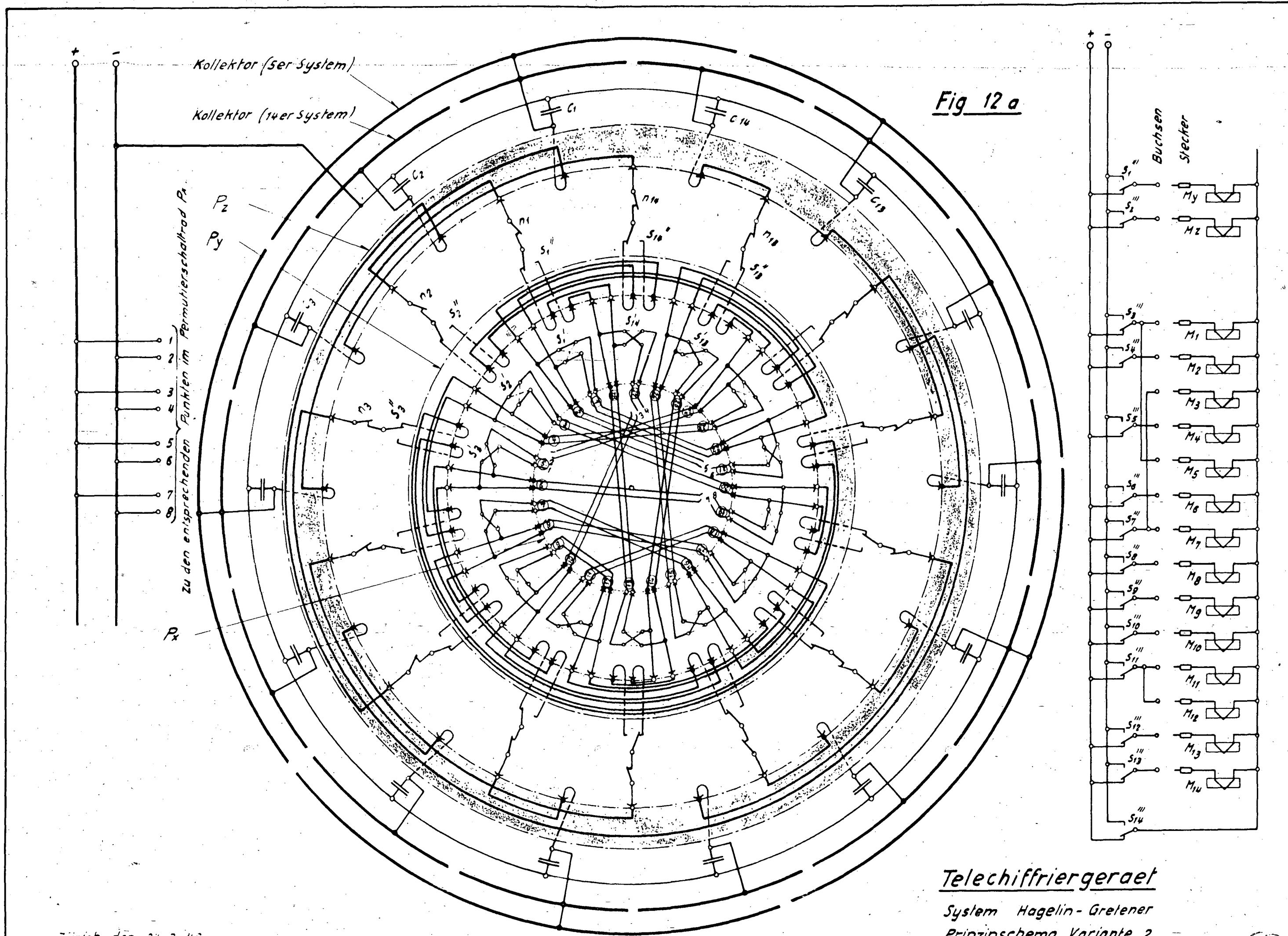


Fig 12 a

Kollektor (5er System)

Kollektor (14er System)

Zu den entsprechenden Punkten im Permutierschaltrod Px

Pz

Py

Px

Buchsen
Stecker

Telechiffriergeraet

System Hagelin-Gretener

Prinzipschema Variante 2

Zürich, den 24. 3. 48

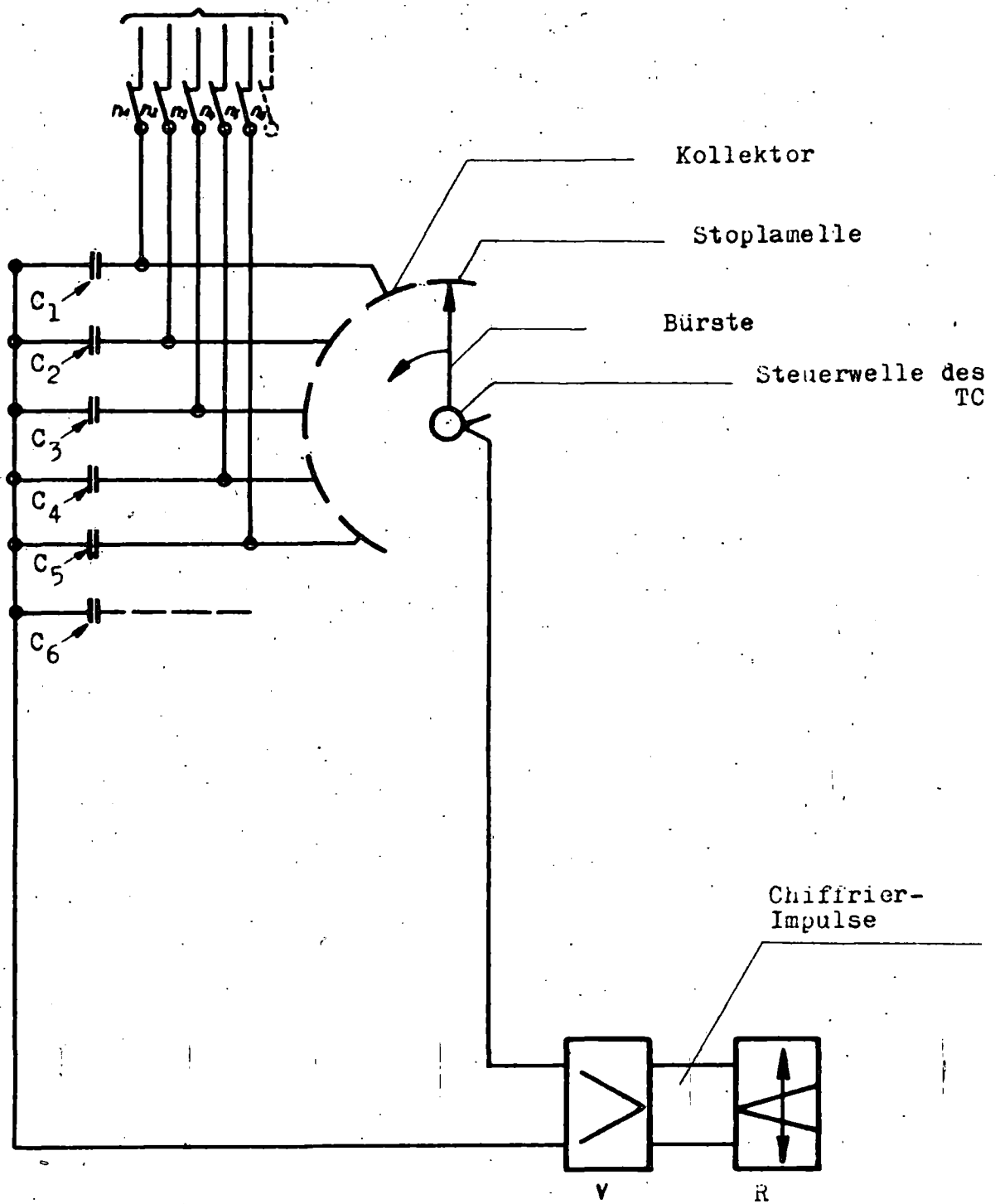
Zu Sⁿ und Umpoler-Kette (Stiftradrkontakte)

Fig. 13

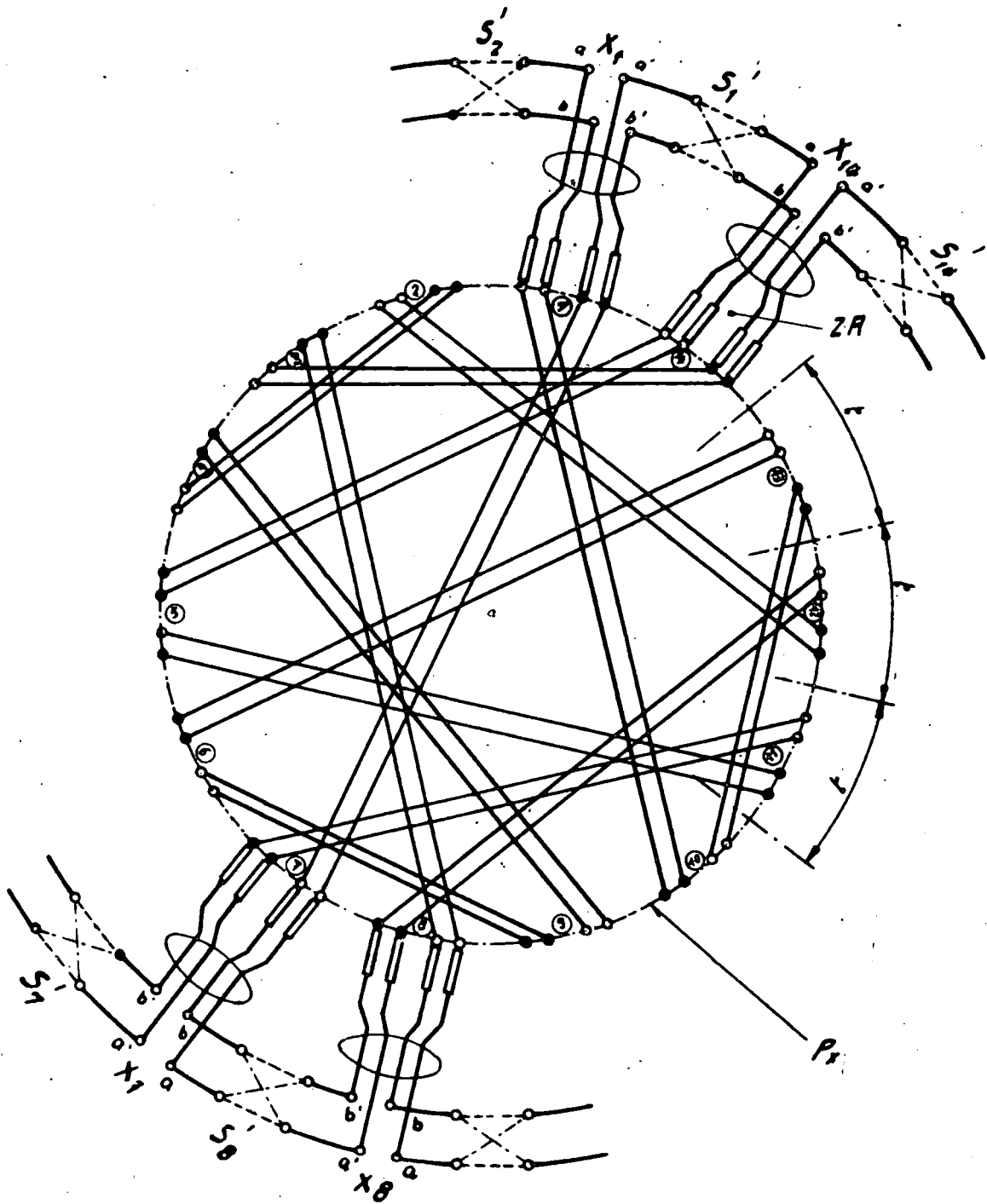


Fig. 14

18 21 16 15 7 12 6 7 5 4 5 1

	1	2	3	4	5	6	7	8	9	10	11	12	13	14
	0	0	0	0	8	0	0	8	0	0	0	0	0	8
A	•	•		•	•									
B		•	•	•						•		•		
C	•	•	•											
D		•	•	•						•				
E	•	•	•		•									
F	•	•			•									
G	•	•	•									•		
H	•			•	•									
I										•				
J		•	•	•						•				
K	•					•	•			•				
L	•		•											
M	•			•		•					•			
N	•			•			•				•			
O	•	•	•	•										
P	•	•				•		•						
Q	•	•	•	•				•						
R	•	•				•	•	•						
S		•	•					•				•		
T		•								•				
U	•		•	•										
V	•					•				•				
W	•			•			•			•				
X						•	•			•		•		
Y						•				•		•		
Z		•	•			•				•				
1				•		•								
2		•	•			•		•		•				
3		•	•			•						•		
4					•			•		•				
5		•						•		•				
6	•	•	•		•							•		
7		•				•				•				
8														•
9		•	•	•	•			•						
/						•								
+					•					•				
-					•									
<						•	•							
>										•		•		
/						•				•				
?		•				•							•	
.										•				
=			•		•								•	
□	•	•	•	•						•				
KZ	5 Drähte nach Bedarf													

	ETK-Schreiber Sicherheitsalphabet mit □			
	Ausg	Mitteil	Datum	Bez
			18.6.47	73.
Dr. Ing. E. Oretener Zürich	GRPS 21/3c			