

~~SECRET~~

INSTRUCTION BOOK
FOR
CONVERTER M-134-T2
AND ASSOCIATED ELECTRICAL TYPEWRITER



PREPARED AT
SIGNAL CORPS LABORATORIES
FORT MONMOUTH, NEW JERSEY

NOVEMBER 10, 1936

~~SECRET~~

~~SECRET~~

INSTRUCTION BOOK
FOR
CONVERTER M-134-T2
AND ASSOCIATED ELECTRICAL TYPEWRITER

No photostats, photographs or other reproductions of matter contained herein are permissible. This service-test instruction book must be accounted for by number to the Director, Signal Corps Laboratories

Prepared at
SIGNAL CORPS LABORATORIES
FORT MONMOUTH, NEW JERSEY

November 10, 1936

~~SECRET~~

~~SECRET~~

By Authority of the Chief Signal Officer

Date 19 Nov 36 Initials WPCNo. 3 of 5 copies made.~~SECRET~~

~~SECRET~~

TABLE OF CONTENTS

	Page
SECTION I. GENERAL DESCRIPTION..... (pars. 1-5)	1
SECTION II. DETAILED DESCRIPTION.....	2
6. Converter M-134-T2.....	2
<u>a.</u> Base Frame.....	2
<u>b.</u> Keyboard.....	3
<u>c.</u> Keyboard Universal Bar.....	3
<u>d.</u> Keyboard Operation Counter.....	3
<u>e.</u> Keyboard Universal Bar Contact Combination.....	3
<u>f.</u> Cipher Disks.....	3
<u>g.</u> Encipher-Decipher Reversing Switch.....	4
<u>h.</u> Cipher Disk Step Forward Mechanism.....	4
<u>i.</u> Tape Transmitter.....	5
<u>j.</u> Plug and Jack Strip.....	6
<u>k.</u> Lamp Strip.....	7
<u>l.</u> Slow Release Relay.....	7
7. Electrical Typewriter.....	7
SECTION III. INSTALLATION..... (par. 8)	7
SECTION IV. OPERATION..... (par. 9)	8
SECTION V. MAINTENANCE..... (par. 10)	8

~~SECRET~~

LIST OF ILLUSTRATIONS

Photographs

- Fig. 1 - Converter M-134-T2 and Electrical Typewriter
- Fig. 2 - Converter M-134-T2, Front View
- Fig. 3 - Converter M-134-T2, Rear View, Tape Transmitter Removed
- Fig. 4 - Converter M-134-T2, Rear View, Covers Removed
- Fig. 5 - Converter M-134-T2, Plan View
- Fig. 6 - Converter M-134-T2, Plan View, Covers Removed
- Fig. 7 - Converter M-134-T2, Plan View, 2 Cipher Disks Removed
- Fig. 8 - Converter M-134-T2, Bottom View, Covers Removed
- Fig. 9 - Converter M-134-T2, Disk Stepping Mechanism
- Fig.10 - Tape Transmitter, Featuring Contact Combination
- Fig.11 - Electrical Typewriter, Plan View
- Fig.12 - Electrical Typewriter, Showing Solenoids
- Fig.13 - Electrical Typewriter, Showing Space and Carriage Return Contacts

Diagrams

- Fig.14 - Schematic Diagram
- Fig.15 - Theory of Reversing Switch
- Fig.16 - Wiring of Tape Transmitter
- Fig.17 - Cipher Disk Connections
- Fig.18 - Converter M-134-T2, Wiring Diagram

~~SECRET~~

INSTRUCTION BOOK

FOR

CONVERTER M-134-T2

AND ASSOCIATED ELECTRICAL TYPEWRITER

SECTION I

GENERAL DESCRIPTION

1. The Converter M-134-T2 in conjunction with the properly modified electrical typewriter constitutes an electromechanical machine by means of which messages may be enciphered or deciphered automatically up to speeds of about 40 words per minute. Operation of the keyboard of the converter to form an intelligible plain-text message, as one would operate a conventional typewriter results in the production, by the electrical typewriter, of a printed unintelligible enciphered cryptogram. Conversely this cryptogram may be deciphered by striking the keys on the keyboard of the converter in accordance with the individual printed characters of the cryptogram, whereupon the electrical typewriter prints the original intelligible plain-text message. The functions of the converter and electrical typewriter end with the production of the cryptogram or the decipherment thereof. In order to transmit the prepared cryptogram to any given destination, it is necessary to employ one of the conventional agencies of communication; i.e., wire, radio, or messenger.

2. The Converter M-134-T2 may be used to encipher or decipher messages without the electrical typewriter. In this case instead of the cryptographic resultant of the converter keyboard operation being printed by the electrical typewriter, each resultant character is indicated by lamp illumination on an alphabetically designated lamp strip. This process requires that each character be noted and then written manually, which is necessarily slow and laborious in comparison with the use of the electrical typewriter. However, given trained and alert teams it is conceivable that a fair rate of speed may be attained. In any event this additional feature of manual transcription permits the use of the converter under circumstances wherein the electrical typewriter may not be available, or temporarily inoperative, or not desired.

3. Briefly the features of encipherment and decipherment affecting cryptographic security are as follows:

~~SECRET~~

a. A celluloid key tape, with pin holes punched in the five-unit code controlling a tape transmitter to progress in variable relationship five cipher disks as switching commutators to establish a resultant for each and every keyboard operation. Each resultant therefore depends upon the initial position of the key tape in the tape transmitter, upon the initial setting of the cipher disks and upon the subsequent positions of each.

b. Switching means for establishing various connections between the tape transmitter and the cipher disks.

4. The power facilities required for operation of the Converter M-134-T2 and the electrical typewriter are 110 volts d.c. with a capacity of at least 250 watts. In the event commercial d.c. is not available, but commercial a.c. is available a small motor-generator set or power pack may be used to obtain the necessary d-c power. In the event no commercial power is available, a small gasoline-engine-driven generator may be used.

5. The following dimensions and weights apply:

	<u>Overall Dimensions</u>	<u>Weight</u>
Converter M-134-T2	- 11" wide, 16" long, 9" high	35 lbs.
Electrical typewriter	- 15" wide, 17" long, 11" high	43 lbs.

SECTION II

DETAILED DESCRIPTION

6. Converter M-134-T2. Reference is made to Figs. 2 to 9 inclusive. The converter comprises a base frame, keyboard, keyboard operation counter, keyboard universal bar contact combination, five rotatable cipher disks operating between stator elements, encipher and decipher reversing switch, five cipher disk step-forward magnets, tape transmitter, plug and jack strip, lamp strip, lamp resistance unit, one slow-release relay, multicontact terminal strip for connection to the electrical typewriter, power switch and lamp switch, power plug and cord, power fuse and incidental wiring.

a. Base Frame. The base frame comprises a modification of the Remington noiseless typewriter as manufactured by the Remington Noiseless Typewriter Works, Middletown, Conn. All elements of the converter are mounted on this frame in order to employ a commercially available structure insofar as practicable.

~~SECRET~~

b. Keyboard. The standard typewriter keyboard is used, so that the operator will not be required to learn a special keyboard. All keys other than the 26 letters of the alphabet and two blanks are omitted. The two blank keys are blocked up inoperative and are provided in order to make the plan view of the keyboard symmetrical as well as providing guide keys for the normal position of the operator's hands. In other words the keyboard is restricted to the 26 letters of the alphabet. Each key bar is provided with a contact extension which operates into contact jaws. Electrically all key bars are connected in common to one side of the circuit and the individual contact jaws are connected to the studs of the stationary plate of the enciphering-deciphering reversing switch. The individual circuits are connected through this switch and then through the cipher disk combination to the electrical typewriter solenoids or the lamps as the case may be. The key contact jaws are of the wiping type and should give a minimum of trouble.

c. Keyboard Universal Bar. The keyboard is equipped with a universal bar mounted transversely and directly beneath the key bars and it is actuated by the depression of any of the keys. The depression of a key serves to rotate this universal bar on its axis, the movement being used for two purposes; i.e., to operate through a yoke coupling the operation counter; and also by means of a lever extension it closes two contact combinations.

d. Keyboard Operation Counter. This counter is provided to record the number of keyboard operations as a check against the number of characters printed; the number of step-forward positions of the key tape; and the number of characters in the message or the cryptogram as the case may be. The counter may be restored to zero at any time by manual operation of the reset lever.

e. Keyboard Universal Bar Contact Combination. These contacts are in "make" relationship with the universal bar in such a manner that the depression of a key causes these contacts to close before the individual key contacts are closed. It is important that this relationship be preserved for proper operation of the machine. Upon permitting the key to rise (return to normal) the universal contacts open after the individual key contacts open. The function of the universal contacts in the circuit is shown in Fig. 14.

f. Cipher Disks. Reference Figs. 6, 7 and 17. The converter is equipped with five cipher disks positioned to rotate between six stator heads as distributors or commutators. Four of these stator heads separate the cipher disks and are provided with distributor faces against each cipher disk. Two end stator heads are provided with distributor faces internally contacting the end cipher disks and externally by means of stud terminals are connected to the key contacts

~~SECRET~~

and the electrical typewriter solenoids or the lamps through the encipher-decipher reversing switch. Each cipher disk presents 26 segments on each face which are in contact with 26 spring and ball contacts on each stator head. The connections through the stator head are direct. The segments on one face of each individual cipher disk are wired in random fashion to the segments on the opposite face of the disk. The particular wiring for each disk and for the combination is shown in Fig. 17. The exposed periphery or band of each disk is designated in 25 positions alphabetically from A to Y, the 26th or Z position being designated by a numeral. The numerals serve to identify the disk in addition to indicating the 26th position. Each disk is readily removable and interchangeable with any other disk. No through shaft is used, each disk being rotatable upon a spring tensioned ball in the center of the stator heads, and in removal any particular disk is simply withdrawn from between the stator heads. In addition to the designation band each disk presents a scalloped edge for two purposes; i.e., to facilitate setting of the disks by hand, and also acting as positioning centers in conjunction with the step-forward mechanism. In setting the disks to an initial position they may be turned in either direction by depressing and holding back the button extensions of the step-forward pawls located directly behind each disk position. As regards electrical continuity through the combination of disk and stator heads there are 26 wires connected to each end stator head and 26 circuits through the disks no matter in which position the disks happen to stop. It will be seen that 26 through circuits are provided at all times even though the relationship of all circuits is altered by any disk movement. One particular circuit is traced through the combination in Fig. 17.

g. Encipher-Decipher Reversing Switch. Reference Figs. 8 and 15. This switch is mounted beneath the keyboard and is operated through a rack and pinion drive, the pinion being extended to a knob in front of the keys. The switch acts as a combination of 26 double-pole, double-throw switches in the 26 circuits from the key contact jaws through the cipher-disk combination to the typewriter solenoids or lamps as the case may be, and it functions to reverse the cipher-disk combination in these circuits. This feature is necessary in order to maintain the reciprocal relationship between the resultant obtained in encipherment with respect to the resultant required in decipherment. As an example and as shown in Fig. 15, with the switch in encipher position and striking the A key results in the printing of a G. Then with disks in the same position and switch thrown to decipher position, the striking of the G key results in the printing of an A.

h. Cipher Disk Step Forward Mechanism. Each of the five cipher disks are equipped with individual stepping mechanisms comprising a magnet solenoid, tension spring, step-forward pawl, and location roller.

~~SECRET~~

The individual magnets are operated by the tape transmitter. Upon the circuit being closed through a given magnet, this magnet draws down the core building up tension in a spring and near the end of the stroke a step-forward pawl is drawn into engagement with a ratchet tooth on the pertinent cipher disk. Upon deenergization of the magnet the power stored in the spring is delivered to step forward the cipher disk through the step-forward pawl after which the step-forward pawl is disengaged. A location roller and arm is properly conjunctioned with this action to definitely establish the stop position of the cipher disk. This roller is beneath the cipher disk and falls into the scalloped edge on the periphery of the disk. The step-forward pawl arms are extended through the cover of the converter into buttons to permit the manual disengagement of the pawls from the cipher disks in order to facilitate the rotation of the disks by hand. The buttons should be depressed and moved to the rear when disengagement is desired.

i. Tape Transmitter. Reference Figs. 10 and 16.

(1) This unit is a modified Western Electric Co. multiplex transmitter 1-B as used commercially in multiplex printing telegraphy. This transmitter operates on the five-unit code from a perforated tape to establish five contact combinations in marking or spacing positions dependent upon the arrangement of the code perforations in groups transversely disposed on the tape. There are 32 different permutative possibilities in the five-unit code. The tape is provided also with a continuous series of perforations in line longitudinally, the spacing being identical with the spacing between code groups, to permit progressing the tape consecutively from one code group to the next. The tape transmitter is equipped with a tape groove and guide; a latched die to permit inserting the tape at any desired code group; a step-forward star wheel engaging the step-forward holes of the tape; five code pins conjunctive with the code-group hole positions of the tape and operative upon five contact levers in marking-spacing positions; and a magnet acting to depress all five code pins from tape engagement and to step forward the tape by ratchet movement on the star wheel to the next code group, after which the code pins are released to assume their tape dictated positions. When a code pin is held down by the circumstance of no hole in the tape, at that time the associated contact lever is held against the spacing-contact bus. On the other hand, when a code pin is permitted to rise through a hole in the tape, the contact lever is moved over to the marking-contact bus.

(2) The modification of the tape transmitter comprises the addition of a contact combination operated by the magnet armature and a wiring rearrangement to adapt the unit for its proper function in the converter.

~~SECRET~~

~~SECRET~~

(3) The function of the tape transmitter in the converter is to step forward the cipher disks in accordance with the key tape. The key tape is made of celluloid rather than paper in order to permit longer repetitive use. Each code group of the key tape establishes, through the code pins and contact levers of the tape transmitter, circuits energizing the pertinent cipher-disk magnets selected which act to step forward the pertinent disks one position, leaving the non-selected magnets in normal position. The circuits from the disk magnets to the tape-transmitter contacts are connected in series-parallel with respect to the contact combination of the tape-transmitter magnet, in order that the disk magnets be not energized until after the tape has been stepped forward and all pins and contact levers are in position. The necessity for this tape-transmitter, magnet-contact combination depends upon whether or not the common connection from power is connected to the marking or spacing bus of the transmitter. If the common is connected to the marking bus, the magnet contacts can be eliminated, but if the common is connected to the spacing bus the inclusion of the magnet contacts is imperative. The common is normally connected to the marking bus but may very readily be changed to the spacing bus. Access to these busses may be had by removing the cover plate of the tape transmitter. The advantage of the use of the marking bus is that a tape hole means step forward of the pertinent cipher disk and is consistent with the telegraphic viewpoint of marking signals. On the other hand, the advantages of the use of the spacing bus are twofold; first, the transmitter contacts are somewhat more positive than in marking position due to spring tensions, and second, being inconsistent with the telegraphic viewpoint, offer possibilities in cryptographic security because the tape no-hole positions normally known as spacing then actually become marking insofar as the cipher-disk magnets are concerned. In either event it will be noted by reference to Fig. 14 that the cipher-disk, tape-transmitter circuit is closed through the contacts of a slow-release relay which in subsequently opening clears the circuits for spring step forward of the cipher disks leaving the circuit normally open. Note: All intercommunicating stations must be in agreement with regard to the use of the marking or the spacing bus for disk step forward.

i. Plug and Jack Strip. Reference Figs. 2 and 14. Five plugs, cords and jacks are provided which are installed in the five connections between the tape-transmitter contacts and the cipher-disk magnets. The plugs are connected to the tape-transmitter contacts and are numbered accordingly from 1 to 5 inclusive. The jacks are connected to the cipher-disk magnets and are also numbered respectively from 1 to 5 inclusive. Accordingly, these connections may be patched across as desired and changed at will as a variable feature tending to further extend the cryptographic security of the machine. All stations must agree in this respect.

~~SECRET~~

~~SECRET~~

k. Lamp Strip. Reference Fig. 1. The lamp strip may be used for the indication of resultants when the electrical typewriter is not used. The lamps are mounted beneath a bakelite strip which is provided with lettered opalescent inserts. One spare insert is also mounted on the strip to preserve the symmetry of the combination. The lamps are rated as 2.2 volts, .25 ampere Tung-Sol flashlight bulbs, non-focusing, as manufactured by the Tung-Sol Lamp Works, Inc., Newark, New Jersey, or equal. A 400-ohm resistance unit is connected in the lamp common.

l. Slow Release Relay. Reference Figs. 4, 8 and 14. The function of this relay is to energize the cipher-disk stepping magnets for sufficient time to insure a complete core travel and to subsequently clear the circuit to the normal or open state. This relay is of 1300 ohms resistance and is equipped with a copper slug for slow release. The contacts are an application of the Burgess inclosed type microswitch. These contacts have proved very dependable in service and should require no attention.

7. Electrical Typewriter. Reference is made to Figs. 11, 12, 13 and 14. This typewriter comprises a modification of the International Business Machines Corporation electromatic typewriter. The modification consists of: the incorporation of 26 solenoid magnets with drag links arranged to operate the 26 letter key bars; the addition of a universal bar operating a contact combination upon the depression of any key bar; and the incorporation of an automatic five-character space contact and solenoid magnet operating upon the space bar; and an automatic carriage-return contact with solenoid magnet operating upon the carriage-return key bar and including a warning bell signal. The spacing contact is operated by every sixth detent of the tabulating rack. The carriage-return contact is operated by a stud at the end of the tabulating rack. The wiring is terminated in a plug strip on the base front of the typewriter proper for engagement with a jack strip at the rear of the converter. A plug and cord are provided for connection to power for the operation of the driving motor.

SECTION III

INSTALLATION

8. Mount the typewriter on the baseboard as shown in Fig. 1. Position the converter in front of the typewriter and engage the plug and jack combination firmly. Clamp the converter in place on the baseboard by tightening the wind nuts provided, otherwise the shock of operation will gradually disengage the two machines. Connect the power plugs of both machines to 110 volts d.c. The driving motor of the typewriter will operate on either 110 volts d.c. or 110 volts a.c., 60 cycles; but 110 volts d.c. is required for the converter. Operate

~~SECRET~~

~~SECRET~~

the power switch of the typewriter, left side of keyboard, to "ON" position. Operate the power switch of the converter to "ON" position, leaving the lamp switch in its "OFF" position. For lamp operation simply disengage the typewriter and operate the lamp switch to "ON" position.

SECTION IV

OPERATION

9. As in the operation of printing-telegraph machines a very definite cadence or in-step operation by the operator is required. Each key must be firmly depressed and released without overlap by another key, or otherwise a faulty encipherment or decipherment will result. After sufficient practice the operator will time the striking of the keys with the sound of the disk step-forward mechanism. A key must not be struck until after the disks have stepped forward. The key tape position, encipher-decipher switch position, cipher-disk position, and tape-transmitter plug and jack setting must be checked carefully before each start.

SECTION V

MAINTENANCE

10. All functions should be checked periodically, particularly the tape-transmitter and cipher-disk stepping features. A special tape may be used for this purpose as for example stepping forward each disk a given number of times and then checking for performance, or the tape may be left out of the transmitter and all disks allowed to step under keyboard operation. The various wiring diagrams should be studied for a correct analysis of any trouble which may occur and before attempting to make any adjustments.

~~SECRET~~



~~SECRET~~

Fig. 2 - Converter M-134-T2, Front View

~~SECRET~~



~~SECRET~~

Fig. 1 - Converter M-134-T2 and Electrical Typewriter

~~SECRET~~

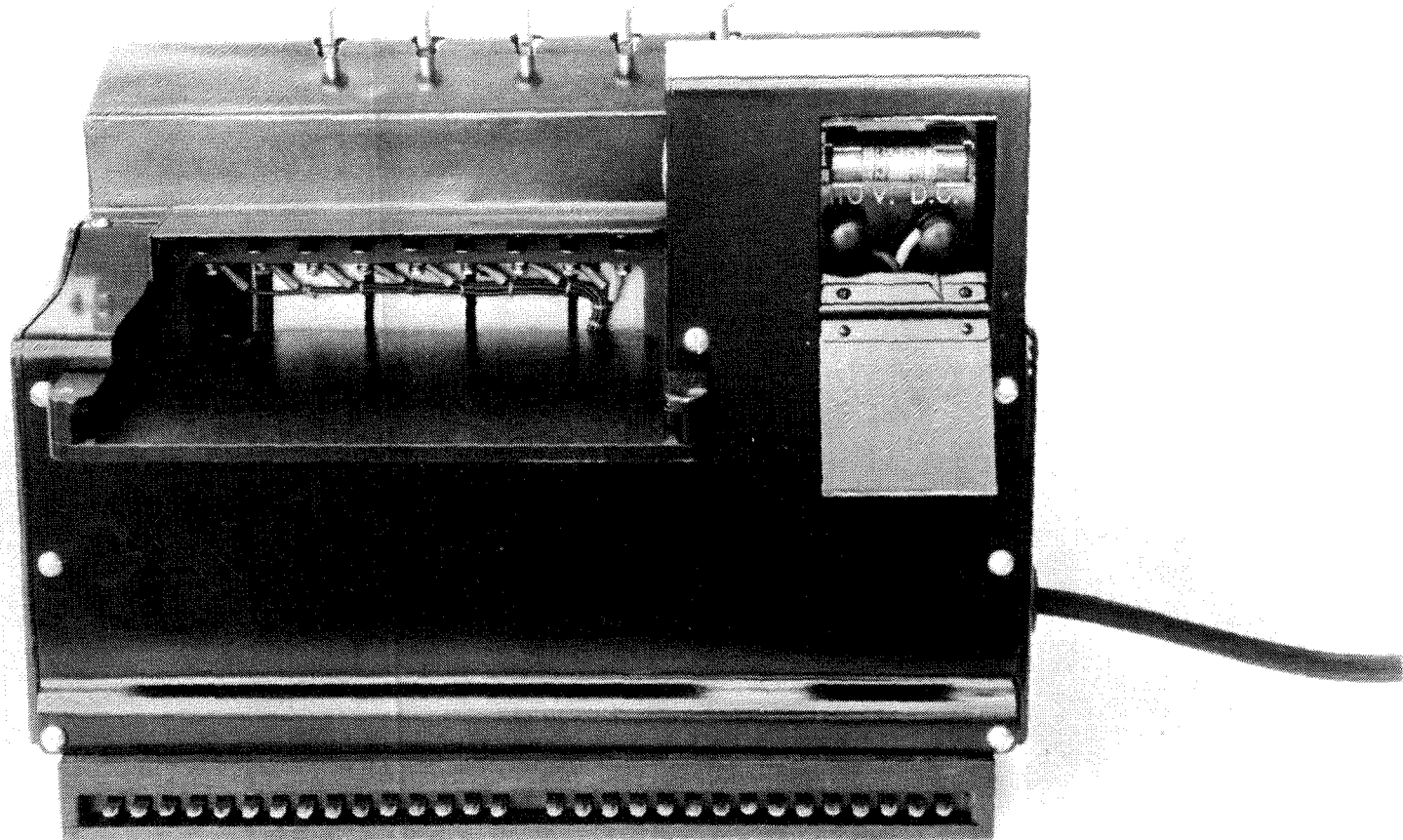

~~SECRET~~

Fig. 3 - Converter M-134-T2, Rear View, Tape Transmitter Removed

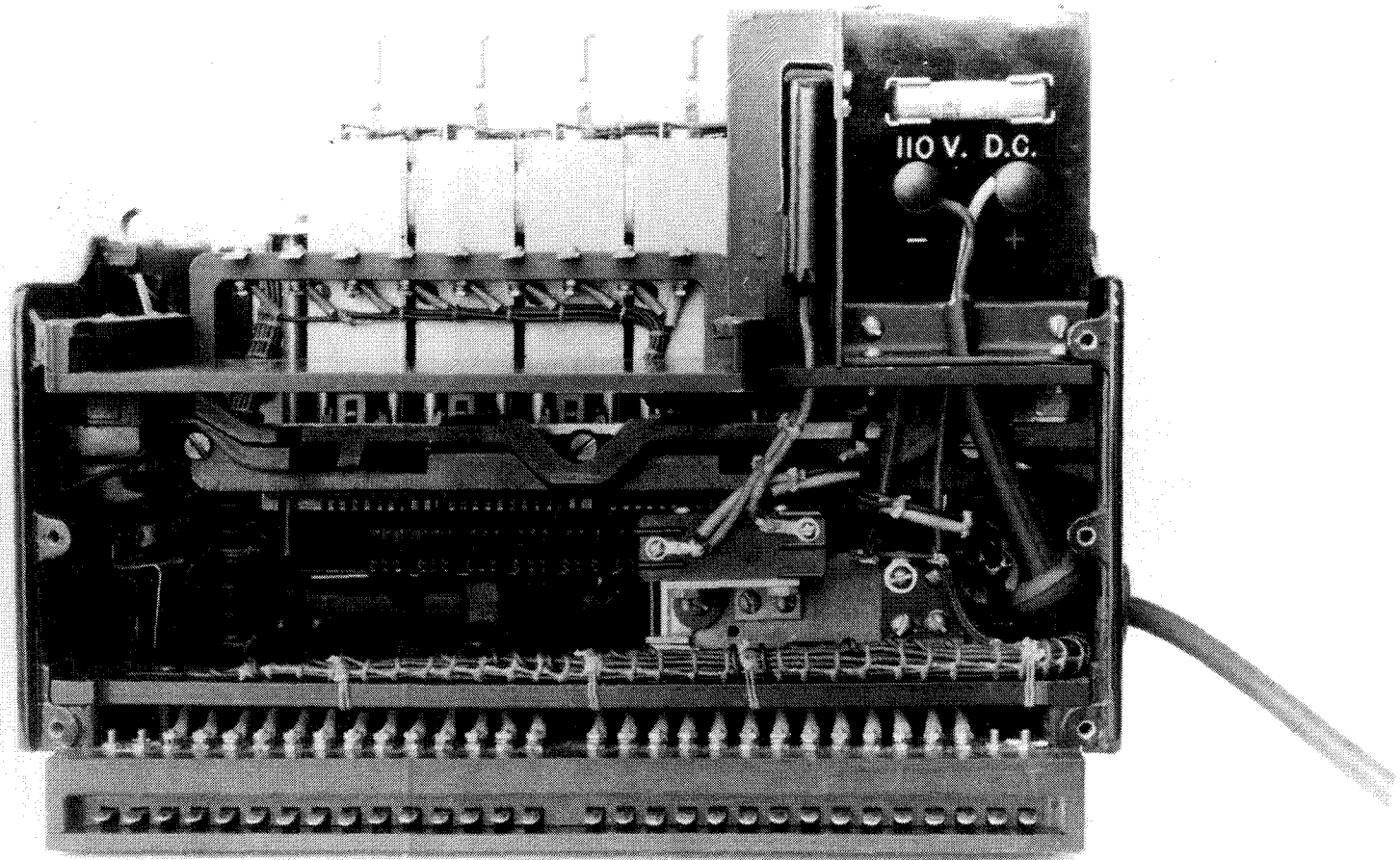

~~SECRET~~

Fig. 4 - Converter M-134-T2, Rear View, Covers Removed

~~SECRET~~

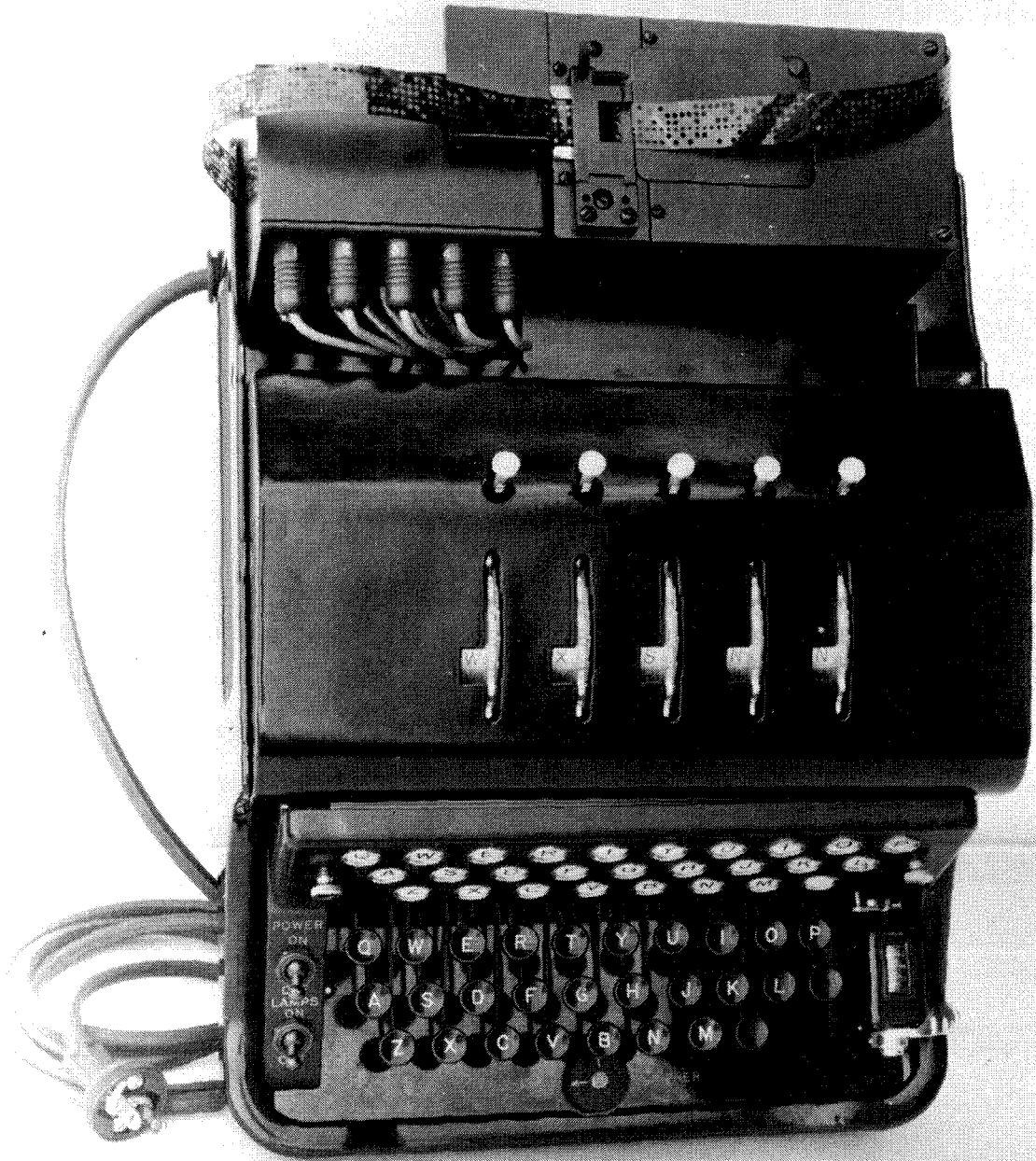

~~SECRET~~

Fig. 5 - Converter M-134-T2, Plan View

~~SECRET~~

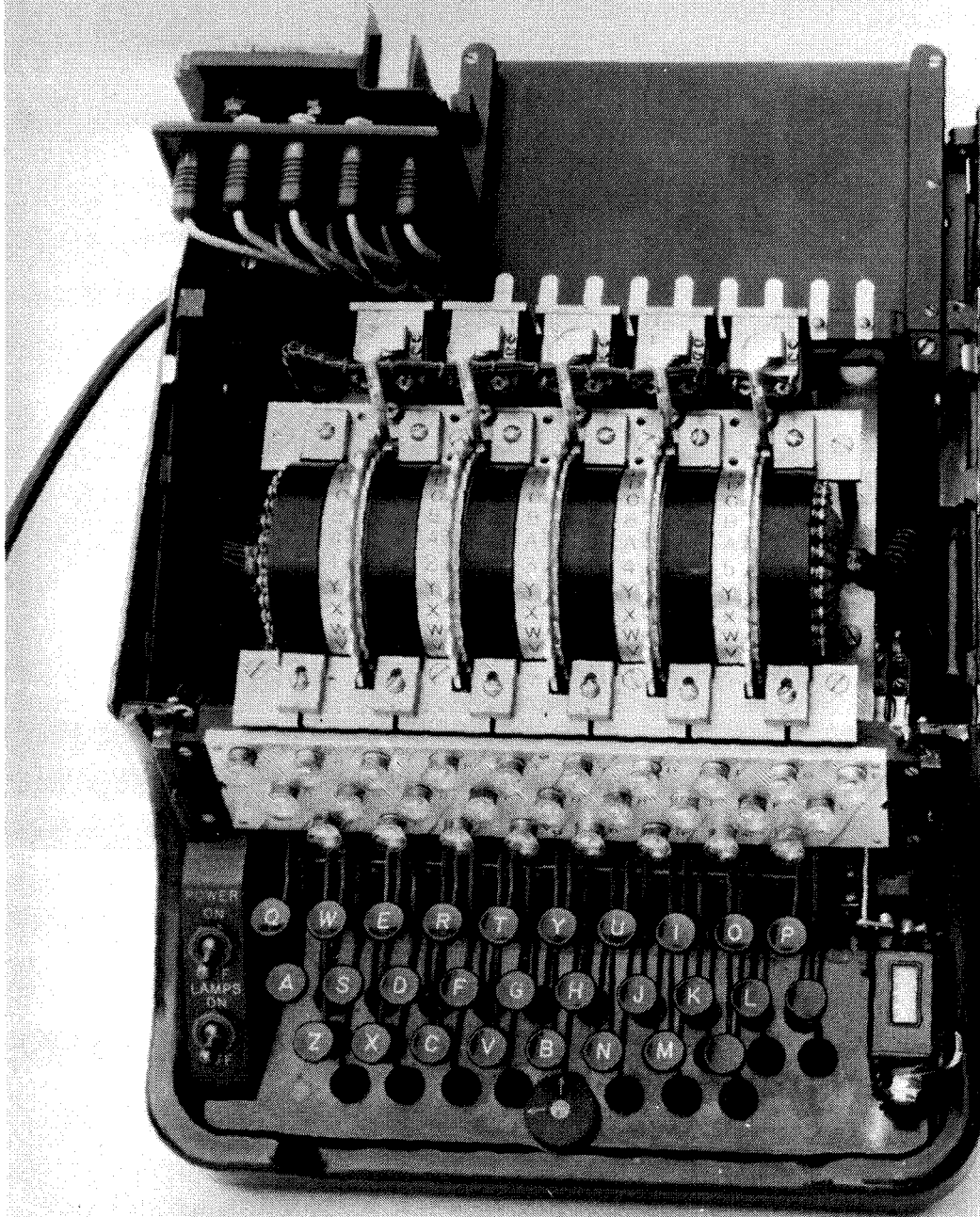

~~SECRET~~

Fig. 6 - Converter M-134-T2, Plan View, Covers Removed

~~SECRET~~

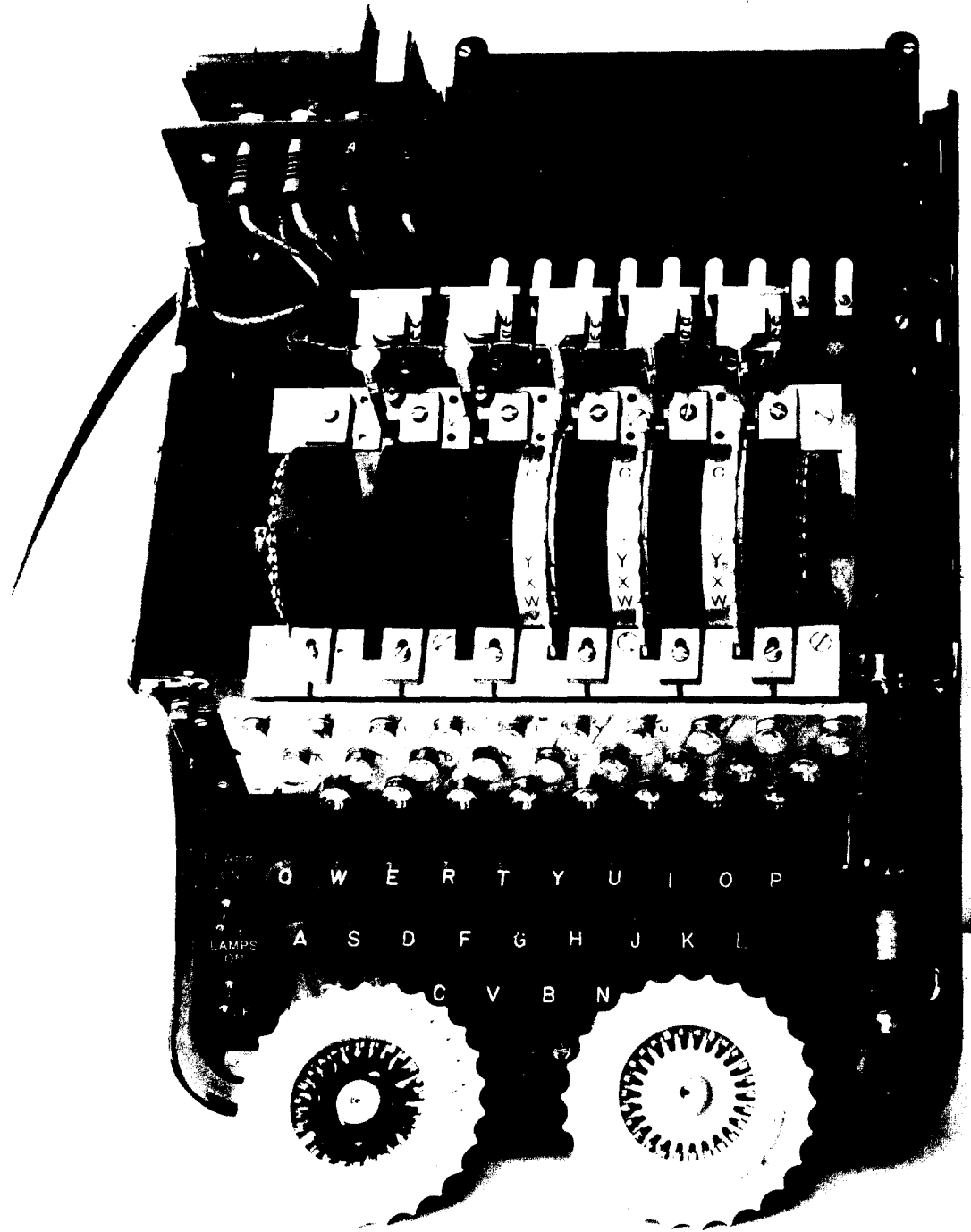

~~SECRET~~

Fig. 7 - Converter M-134-T2, Plan View, 2 Cipher Disks Removed

~~SECRET~~

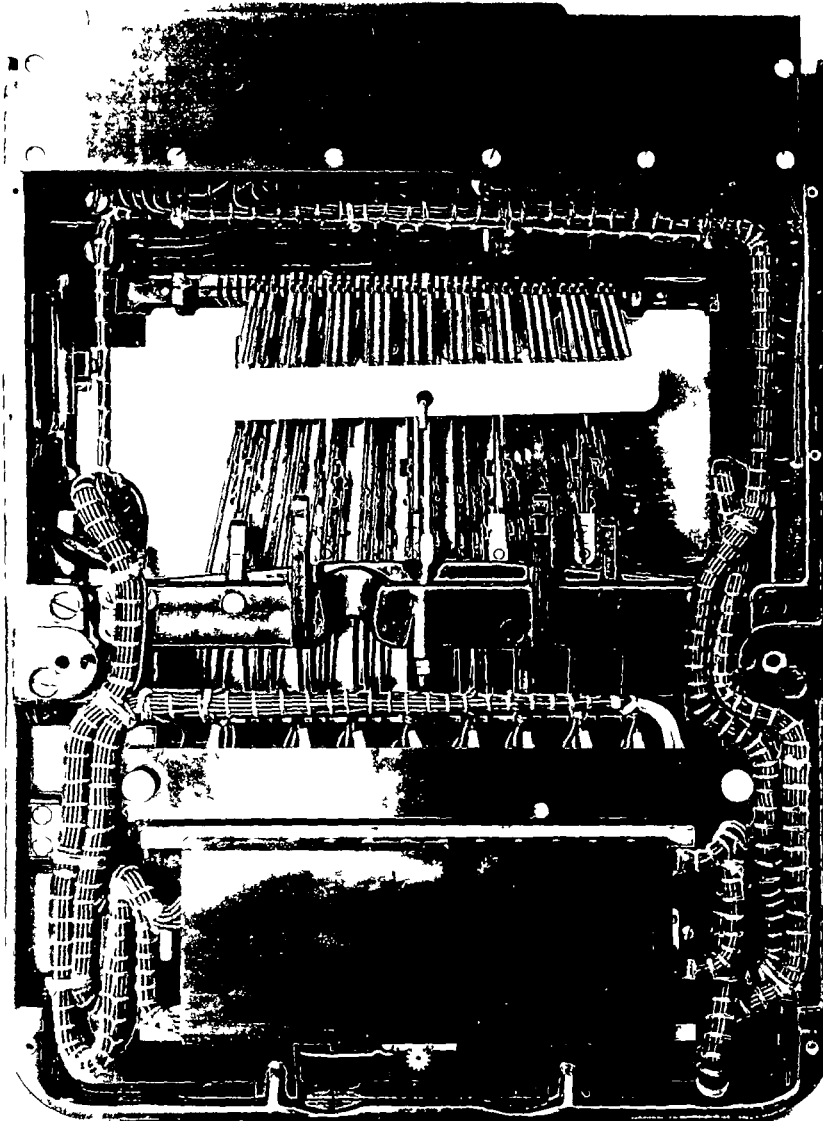

~~SECRET~~

Fig. 8 - Converter M-134-T2, Bottom View, Covers Removed

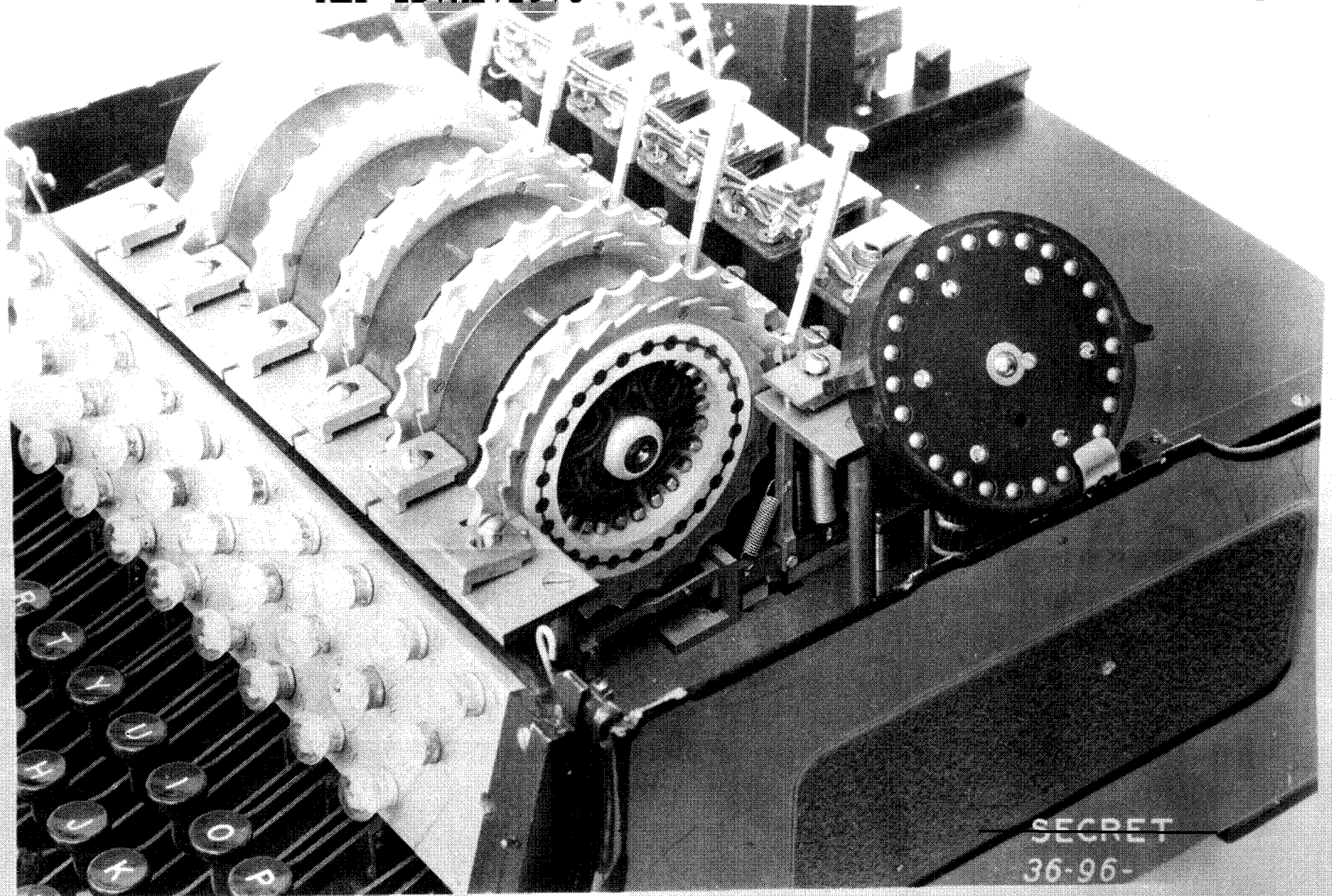

SECRET
36-96-

~~SECRET~~

Fig. 9 - Converter M-134-T2, Disk Stepping Mechanism

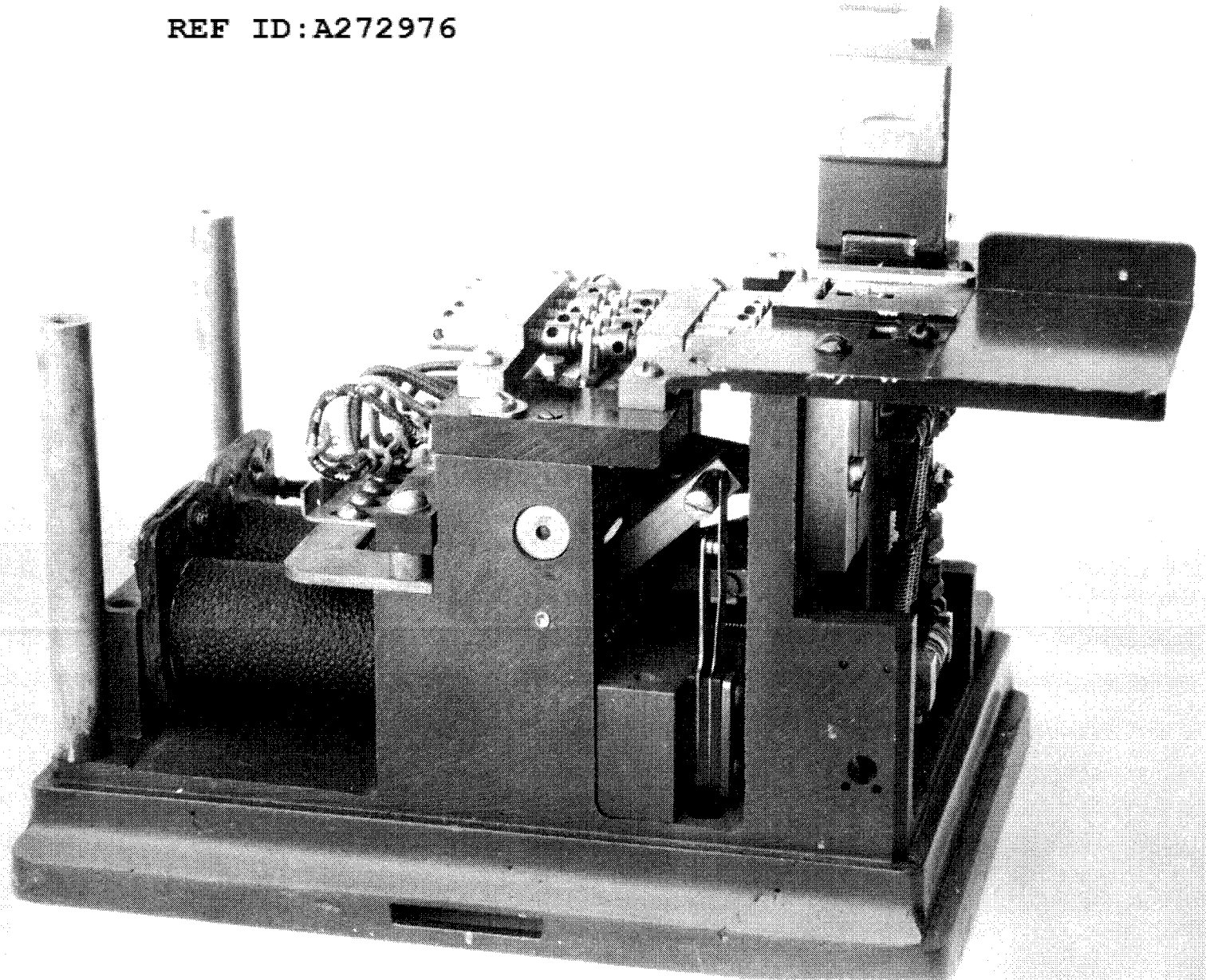

~~SECRET~~

Fig.10 - Tape Transmitter, Featuring Contact Combination

~~SECRET~~

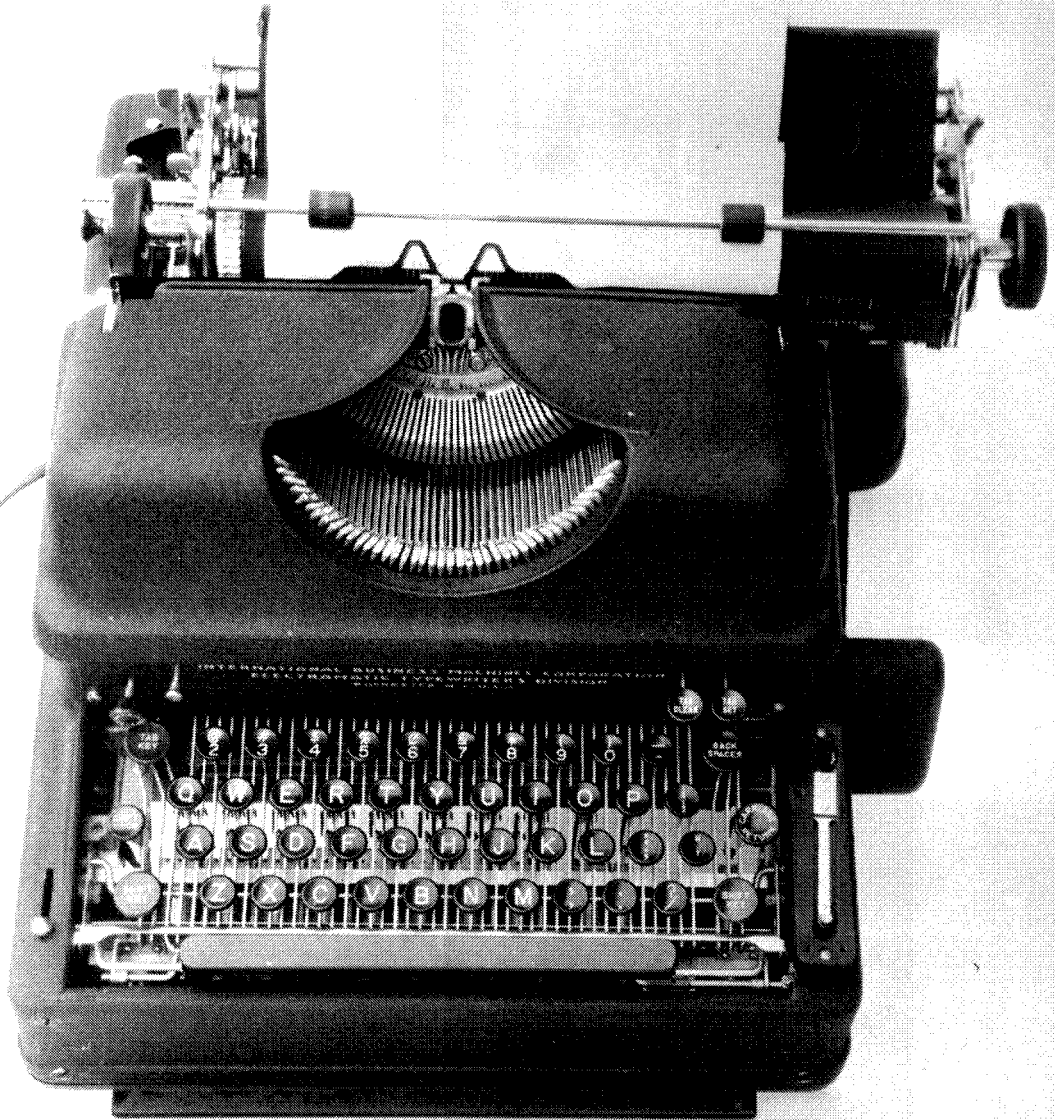

~~SECRET~~

Fig.11 - Electrical Typewriter, Plan View



~~SECRET~~

Fig.12 - Electrical Typewriter, Showing Solenoids

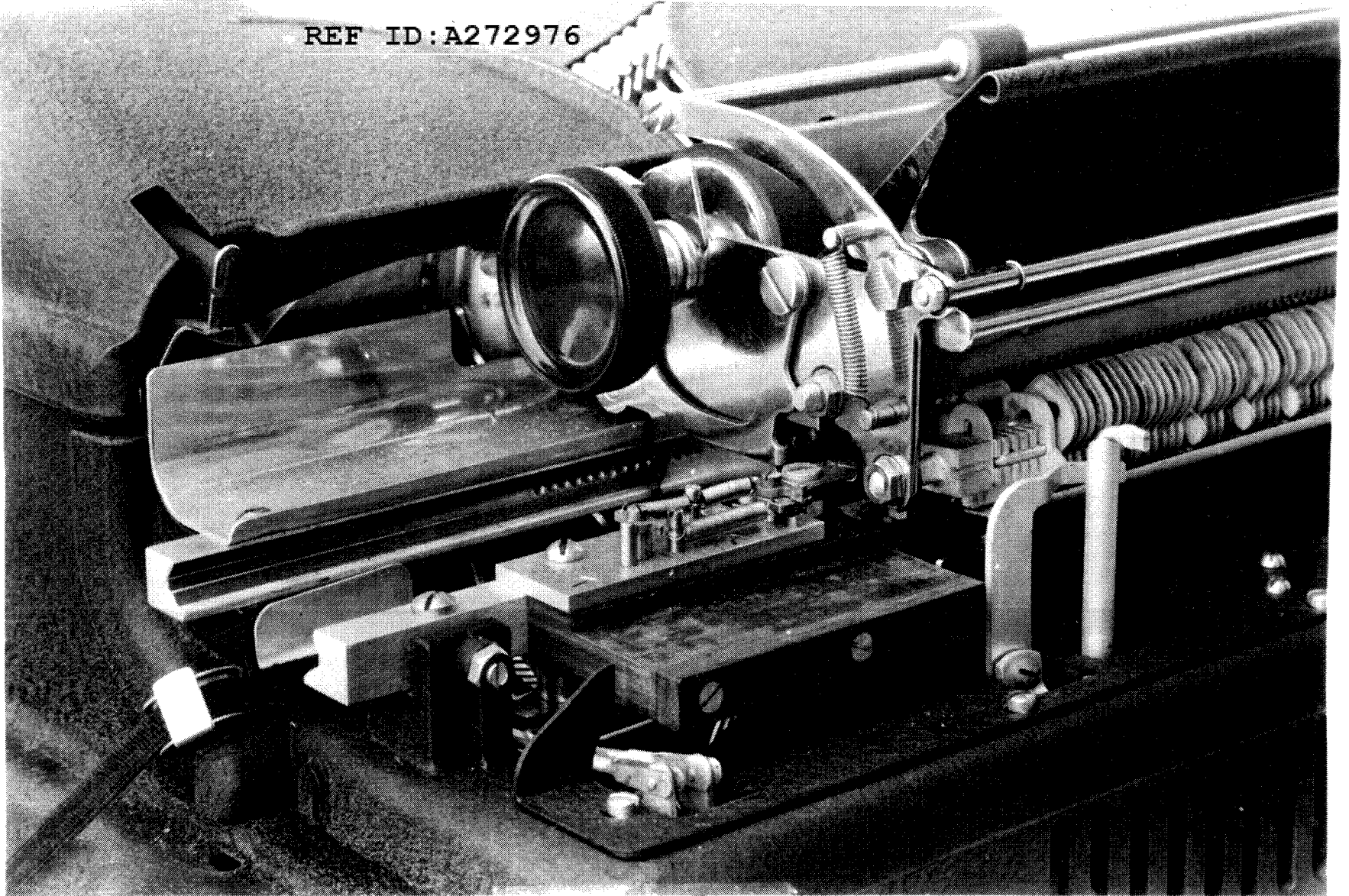

~~SECRET~~

Fig.13 - Electrical Typewriter, Showing Space and Carriage Return Contacts

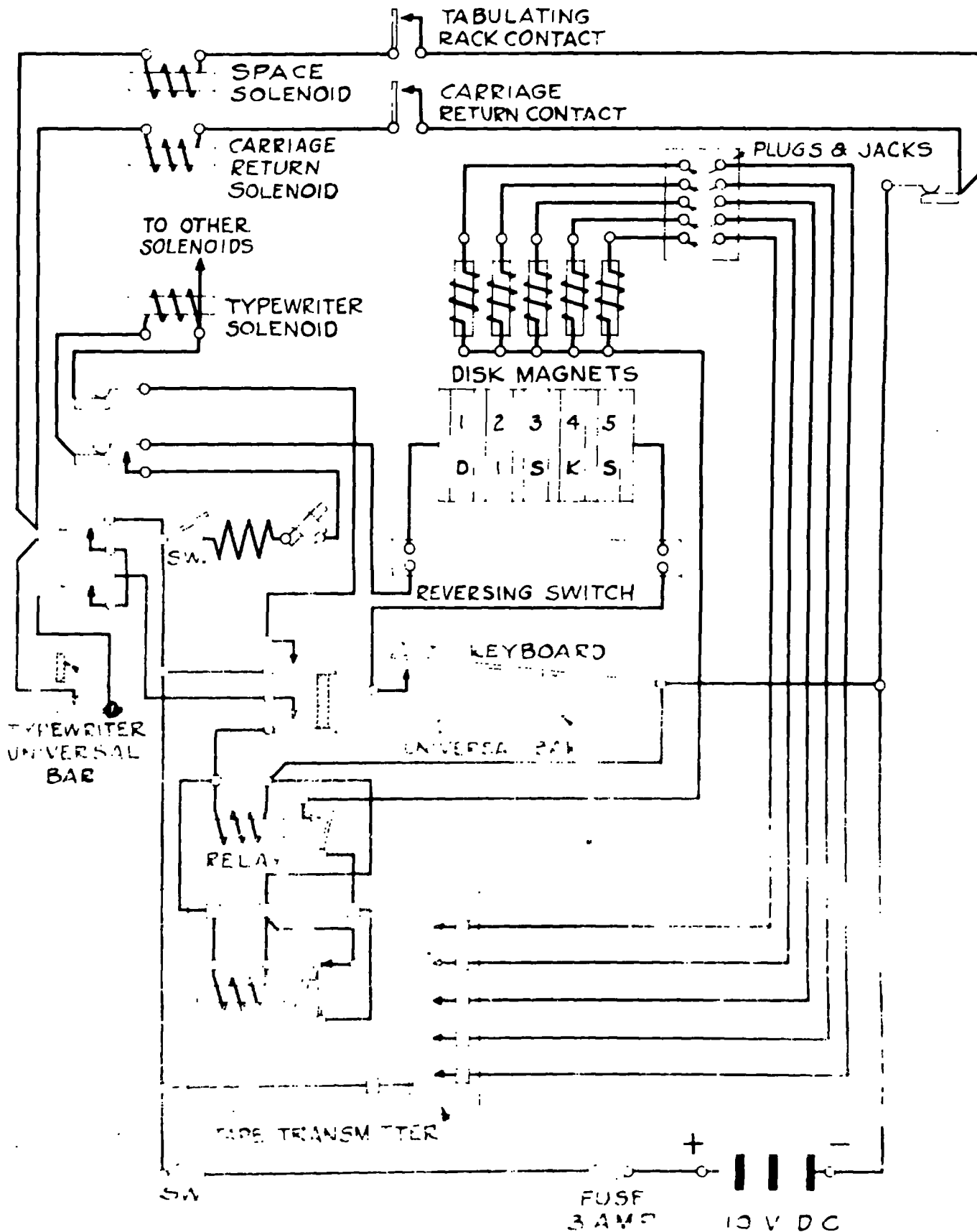

○ TAP TRANSMITTER TERMINALS
 ↑ CONVERTER TERMINALS
 ○ TYPEWRITER TERMINALS

~~SECRET~~

FIG. 14
SCHEMATIC DIAGRAM

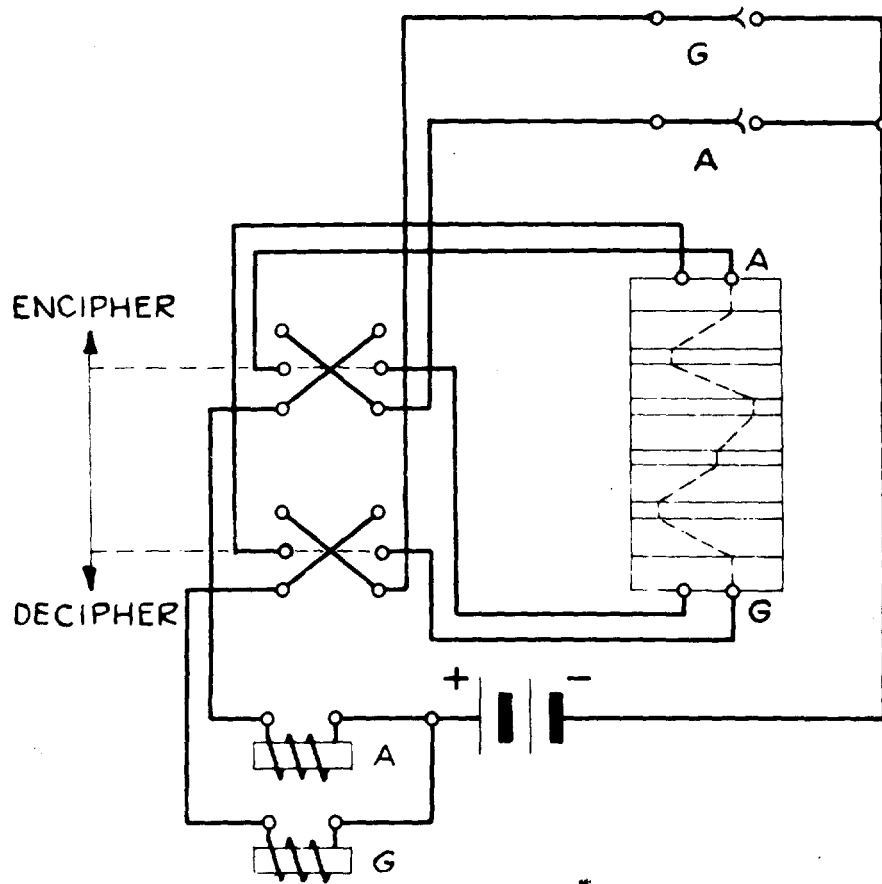

~~SECRET~~

FIG. 15
THEORY OF REVERSING SWITCH

~~SECRET~~

FIG. 16
WIRING OF TAPE TRANSMITTER

ACTUAL DISK DESIGNATIONS
AND STUD POSITIONS

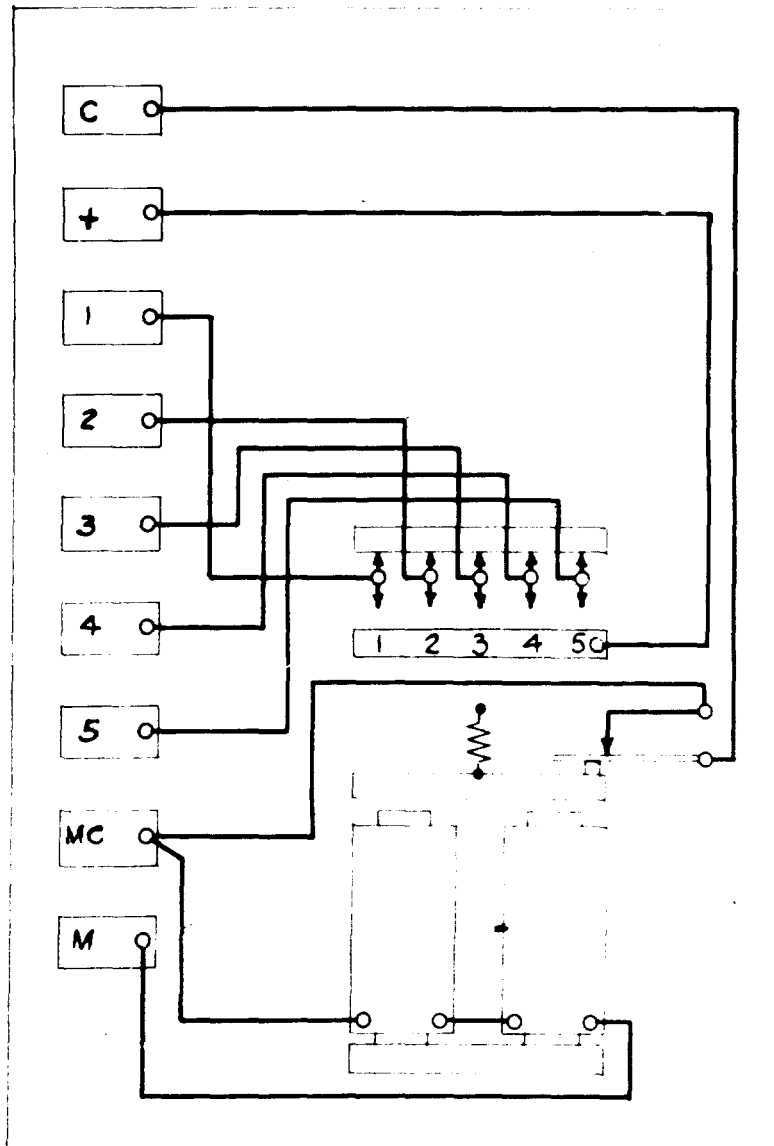
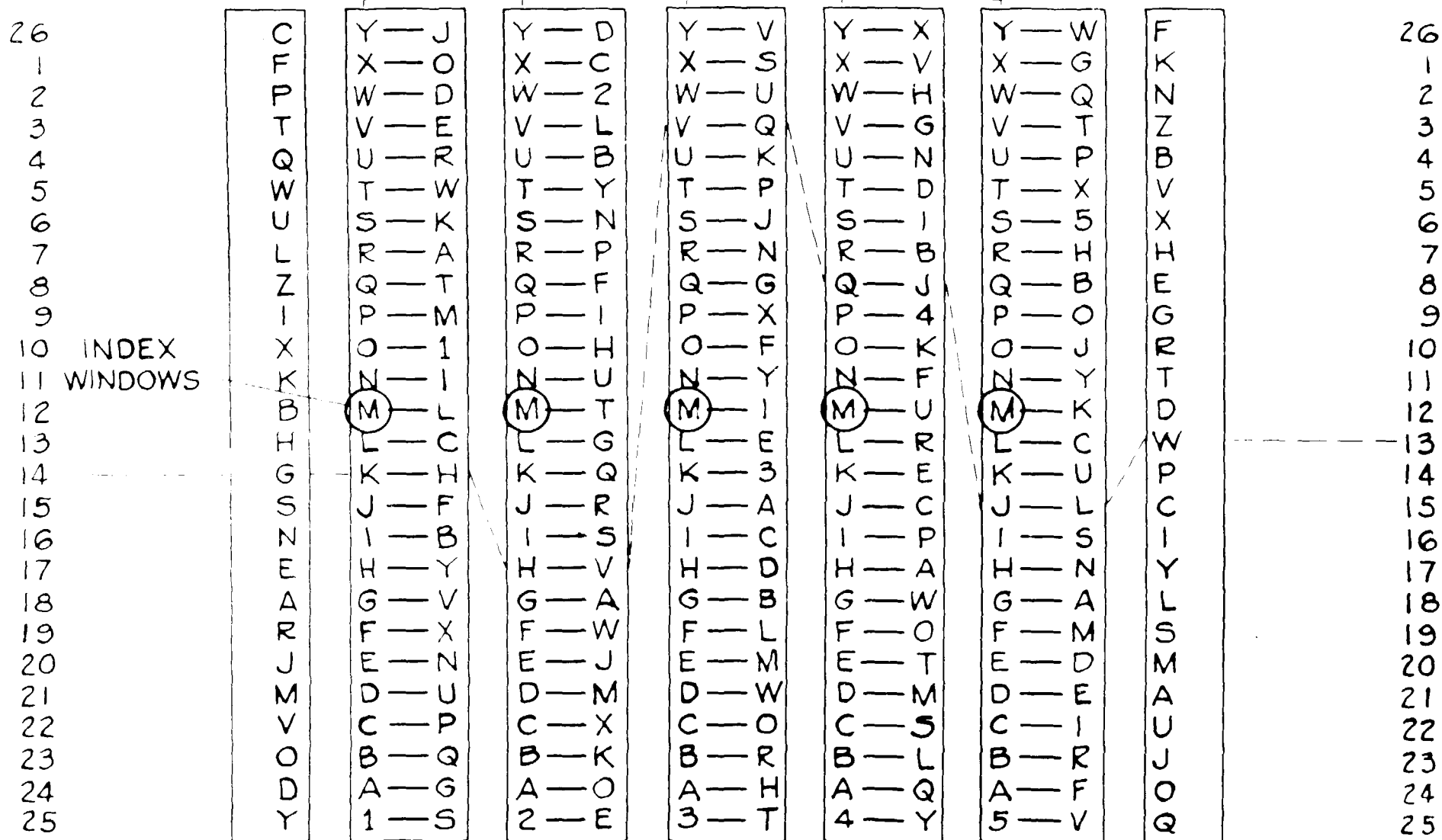

RIGHT STATOR

CROSS WIRING OF INDIVIDUAL DISKS

LEFT STATOR

FIG. 17 CIPHER DISK CONNECTION

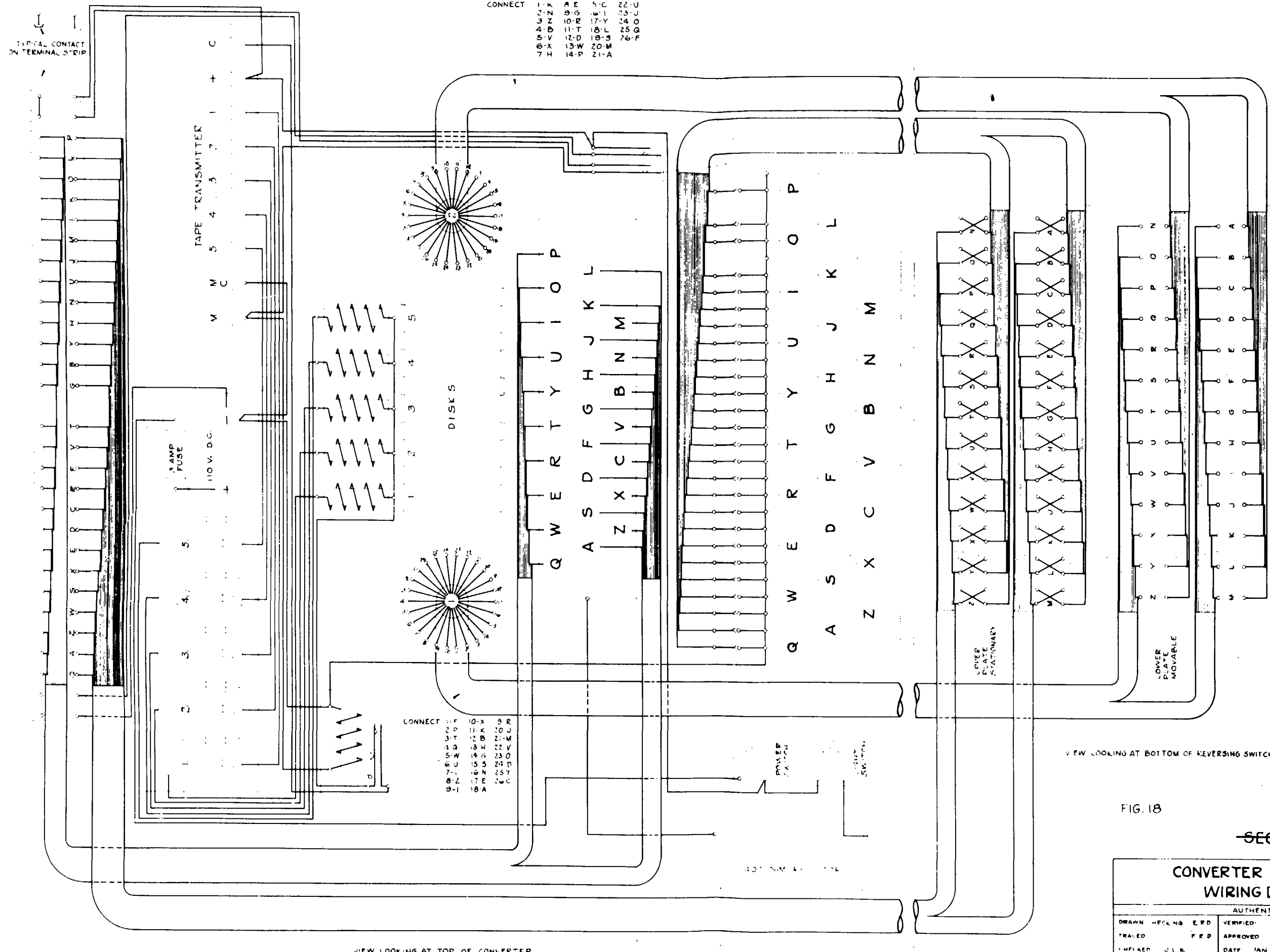

CONNECT

1	A	E	5-C	22	C
2	B	F	6-D	23	D
3	C	G	7-E	24	E
4	D	H	8-F	25	F
5	E	I	9-G	26	G
6	F	J	10-H	27	H
7	G	K	11-I	28	I
	H	L	12-J	29	J
	I	M	13-K	30	K
	J	N	14-L	31	L
	K	O	15-M	32	M
	L	P	16-N	33	N
	M	Q	17-O	34	O
	N	R	18-P	35	P
	O	S	19-Q	36	Q
	P	T	20-R	37	R
	Q	U	21-S	38	S
	R	V	22-T	39	T
	S	W	23-U	40	U
	T	X	24-V	41	V
	U	Y	25-W	42	W
	V	Z	26-X	43	X
	W		27-Y	44	Y
	X		28-Z	45	Z
	Y		29-A	46	A
	Z		30-B	47	B
			31-C	48	C
			32-D	49	D
			33-E	50	E
			34-F	51	F
			35-G	52	G
			36-H	53	H
			37-I	54	I
			38-J	55	J
			39-K	56	K
			40-L	57	L
			41-M	58	M
			42-N	59	N
			43-O	60	O
			44-P	61	P
			45-Q	62	Q
			46-R	63	R
			47-S	64	S
			48-T	65	T
			49-U	66	U
			50-V	67	V
			51-W	68	W
			52-X	69	X
			53-Y	70	Y
			54-Z	71	Z
			55-A	72	A
			56-B	73	B
			57-C	74	C
			58-D	75	D
			59-E	76	E
			60-F	77	F
			61-G	78	G
			62-H	79	H
			63-I	80	I
			64-J	81	J
			65-K	82	K
			66-L	83	L
			67-M	84	M
			68-N	85	N
			69-O	86	O
			70-P	87	P
			71-Q	88	Q
			72-R	89	R
			73-S	90	S
			74-T	91	T
			75-U	92	U
			76-V	93	V
			77-W	94	W
			78-X	95	X
			79-Y	96	Y
			80-Z	97	Z
			81-A	98	A
			82-B	99	B
			83-C	100	C

CONNECT

1	A	E	5-C	22	C
2	B	F	6-D	23	D
3	C	G	7-E	24	E
4	D	H	8-F	25	F
5	E	I	9-G	26	G
6	F	J	10-H	27	H
7	G	K	11-I	28	I
8	H	L	12-J	29	J
9	I	M	13-K	30	K
10	J	N	14-L	31	L
11	K	O	15-M	32	M
12	L	P	16-N	33	N
13	M	Q	17-O	34	O
14	N	R	18-P	35	P
15	O	S	19-Q	36	Q
16	P	T	20-R	37	R
17	Q	U	21-S	38	S
18	R	V	22-T	39	T
19	S	W	23-U	40	U
20	T	X	24-V	41	V
21	U	Y	25-W	42	W
22	V	Z	26-X	43	X
23	W		27-Y	44	Y
24	X		28-Z	45	Z
25	Y		29-A	46	A
26	Z		30-B	47	B
27			31-C	48	C
28			32-D	49	D
29			33-E	50	E
30			34-F	51	F
31			35-G	52	G
32			36-H	53	H
33			37-I	54	I
34			38-J	55	J
35			39-K	56	K
36			40-L	57	L
37			41-M	58	M
38			42-N	59	N
39			43-O	60	O
40			44-P	61	P
41			45-Q	62	Q
42			46-R	63	R
43			47-S	64	S
44			48-T	65	T
45			49-U	66	U
46			50-V	67	V
47			51-W	68	W
48			52-X	69	X
49			53-Y	70	Y
50			54-Z	71	Z
51			55-A	72	A
52			56-B	73	B
53			57-C	74	C
54			58-D	75	D
55			59-E	76	E
56			60-F	77	F
57			61-G	78	G
58			62-H	79	H
59			63-I	80	I
60			64-J	81	J
61			65-K	82	K
62			66-L	83	L
63			67-M	84	M
64			68-N	85	N
65			69-O	86	O
66			70-P	87	P
67			71-Q	88	Q
68			72-R	89	R
69			73-S	90	S
70			74-T	91	T
71			75-U	92	U
72			76-V	93	V
73			77-W	94	W
74			78-X	95	X
75			79-Y	96	Y
76			80-Z	97	Z
77			81-A	98	A
78			82-B	99	B
79			83-C	100	C

VIEW LOOKING AT BOTTOM OF REVERSING SWITCH

VIEW LOOKING AT TOP OF CONVERTER

FIG. 18

SECRET

CONVERTER M-134-T2 WIRING DIAGRAM			
AUTHENTICATION			
DRAWN: HCK/NG	VERIFIED: EFD	APPROVED: FRD	ENGINEER: A.A.G.
CHECKED: J.L.E.	DATE: JAN 7 1935	APPROVED: [Signature]	CH. OF SECTION: [Signature]
SIGNAL CORPS LABORATORIES U. S. ARMY FORT MONMOUTH NEW JERSEY			ES-D-2751-B